

2010 Sale Donkey List

Lot #	Miniature Donkey	Lot #	Miniature Donkey
1	The Elms Miss Fancy Pants	25	TTW Tallahassee
2	Hill Co Mini's Flaming Vixen	26	BJ Monique
3	Mini Moon's She's a Hottie	27	West Prairie Jane
4	Ass-pirin Acres Drop Dead Gorgeous	28	Cedar Creek Foxy Lady***
5	West Prairie Josea	29	The Elms La Reine Helene
6	The Elms Lady in the Mist	30	LN Glo Sam and Glo Doug++
7	Assphalt Acres Peaches	31	Ass-pirin Acres Fancy That
8	Heiken's Ark Valerie D	32	Arcadian Adell
9	Hill Co Mini's Prada	33	West Prairie Anna
10	Continental Naomi	34	Heiken's Ark Lisha LB
11	Merry-Go-Round's Pebbles^^^	35A	The Elms Red Hot Rudy ^^
12	BJ Patty Lou	35B	The Elms Whistler^^
13	Ass-pirin Pacres Pala	35C	The Elms Makenna's Gold^^
14	Red Gate's Silver Rose^^	36	Hill Co Mini's J Lo
15	Hill's Haven Shakira	37	Continental Louise
16	Kiterra's Salsa Dancer***	38	Mini Moons Kisses of Gold***
17	Ass-pirin Acres Miss Gabor	39	TTW Moffit Midori
18	Arcadian Brettina	40	BJ Cleveland Girl
19	The Elms Little Pearl	41	Assphalt Acres Alison
20	Hill Co Mini's Solstice	42	Hill Co Mini's Mocha
21	TTW Valintino 50's Waka Blue	43	Ass-pirin Acres Nachina
22	Legendary Fanny	44	Legendary Sophie
23	Perfection's Honey Nut***	45	Red Gate's Lily^^
24	Merry-Go-Round's Silhouette^^	46	KDL Pimento***

^^^ Foal by side

*** Bred

^^ Jack

++ Driving Donkey with Cart & Harness

See WWW.DONKEYS.NET for Pictures

2011 Great American Miniature Donkey Sale
Sale Day – Saturday, July 30, 2011

Now is the time to select those special donkeys you will want to represent your farm breeding program in the 2011 Sale. Sale planning begins in December, deadline early March. Contact us anytime to discuss potential entries and details.

Great American Miniature Donkey Sale Catalog, copyright 2010



Saturday July 31, 2010
Historic Lebanon, Ohio - Fairgrounds

.....
8th Annual Sale Featuring Select Miniature Donkeys
Offered by Breeders from Across North America

.....
Quality Conformation, Diverse Pedigrees, All Colors,
Jennets - Yearlings, 2 year olds, Mature, Bred and With Foal
Select Jacks & Gelding Driving Team With Fancy Cart & Harness

.....
Visit WWW.DONKEYS.NET for
Web Catalog with pictures

Sale Sponsors
 Elms Farm Miniature Donkeys
 The Elms Farm
 Martha & Dowell Howard
 Mason, Ohio
 mhoward@eos.net
 513-398-3341

Welcome To
The Great American Miniature Donkey Sale
Historic Lebanon, Ohio
At the Warren County Fairgrounds

June, 2010

Dear Donkey Enthusiast,

We are pleased to invite you to 8th annual Great American Miniature Donkey Sale, a select sale featuring quality registered miniature donkeys. The Sale will take place on Saturday, July 31, 2010 at 12:30 PM, at the Warren County Fairgrounds, next to the Lebanon Raceway, in Building C, in Lebanon, Ohio. We hope you plan to attend.

The Sale will consist of 46 miniature donkey lots. These miniature donkeys have been selected from those offered for consideration. Top breeders are consigning their best, as these donkeys publicly represent their farm and breeding program. It would literally take you many days, and thousands of miles, to view an assortment of available, quality stock like you will see represented at the Sale.

The selected miniature donkeys represent diverse bloodlines, great conformation, and a variety of sizes, colors & ages to attract breeders, show people, and donkey & equine lovers everywhere. Full information on each, including pictures (as consignors make them available), may be found on our web page, www.donkeys.net.

There is something for everyone here, whether you are an experienced breeder, or just getting started. Jennets include; yearlings, coming 2 year olds, mature jennets, bred jennets, and jennets with foals on the side. A trained driving gelding team with fancy buggy & harness is being offered as well as 3 select breeding jacks. Donkey tack and gifts will be available. Whether you are looking for a jennet, a jennet with foal, brood jennets for your breeding program, a herd sire, a driving team ready to go or a loving pet, you are assured of finding only quality miniature donkeys at this sale.

This Donkey Sale is more than just an auction; it is an event, a 'happening'. Donkey enthusiasts everywhere look forward to events such as this and we expect a large turnout from across the Continent. It is an opportunity for folks, both those with years of experience, and those first exploring miniature donkeys, to get together, share experiences, learn from each other, have some fun, make new friends, renew old friendships, and, oh yes, see, bid on, and purchase some of the finest quality miniature donkeys in North America

We hope you plan to attend this year's Great American Miniature Donkey Sale. We are confident you will enjoy it.

Thank You for Your Support

Martha L. Dowell Howard

Absentee Bidding –You must be registered prior to the Sale to phone bid or to bid through another person. Do this early. Please review registration details at www.donkeys.net or call 513-398-3341, 513-225-1771 or 513-919-5613.

Sale Day Telephones: 513-225-1771 and 513-919-5613.

The Great American Miniature Donkey Sale
Schedule of Events

FRIDAY JULY 30, 2010 SALE SET-UP DAY

Friday is primarily a set-up and check-in day for the Sale. All donkeys must be on site by 4:00 to allow for consignor and vet check-in. There will be limited viewing during the late afternoon. Events are planned as follows:

Viewing Begins	3:00
Consignor's Invitational Dinner	6:00
Measurement	7:00

SATURDAY JULY 31, 2010 SALE DAY

Saturday is the Sale Day. Viewing will begin at 8:00. Breakfast & lunch will be available for purchase. The Donkey Sale starts at 12:30 and checkout begins shortly after the last lot is sold. The cashier will not be available for settlement until after the Sale ends. Donkey tack, gifts, useful items and curios will be available.

Viewing Starts	8:00
Sale Vendors	9:00
Sale Starts	12:30
Silent Auction Ends	10 minutes after Sale ends
Payment, Vet Papers	Shortly <u>after</u> last lot is sold
All Donkeys Removed	before 8:00 PM

SALE LOCATION & DIRECTIONS

The Sale will be held at the Warren County Fairgrounds, Bldg C, adjacent to Lebanon Raceway, on Route 48, (660 N. Broadway, Lebanon, OH 45036), 0.7 miles north of the town center of Lebanon, OH. The Lebanon Raceway, a private company, will be in operation, so no parking on paved areas. Parking for the Sale will be marked.

From I-75, take exit #29 (Monroe, Lebanon, Rt 63) east to Lebanon, 7 miles. Turn left on Broadway (Rt 48 North), go 0.7 miles to the Fairground.

From I-71, take exit #28 (Rt 48), turn North, go about 2 miles to Rt 123, exit west toward Lebanon, go 1 mile, turn right on Broadway, go 0.7 miles to the Fairground

Auctioneering & Clerking

Kevin Wendt, Auctioneer

23855 State Route 161

Irwin, OH 43029

419-566-1599

www.thewendtgroup.com

kevin@thewendtgroup.com

The Great American Miniature Donkey Sale

TERMS AND CONDITIONS

Terms: Terms of the sale are cash, good check, or credit card (surcharge) with photo ID. All donkeys must be paid for immediately at sale end. No donkeys may be removed before payment or Sale close. All donkeys must be removed by 8 PM. (We can help if you want to attend / phone bid, but won't have a trailer at the Sale.)

Bidding: All donkeys sell to the highest bidder. Any disputes or challenges will be settled by the auctioneer, and his decision will be final. The auctioneer may reject any or all bids. Bids are per lot. Jennets with foals on the side sell as one lot.

Risk: Owners assume all risk for their donkey up to the point of sale. Buyers assume all risk at the moment the auctioneer declares the donkey sold. Under Ohio Law, all persons attending the Sale do so at their own risk. The Management, their staff, auctioneers & their staff do not assume responsibility for, and disclaim any liability of any kind for; accidents, loss (also animals), and/or personal property damages.

Announcements: Sale day announcements from the auction block take precedence over the material in the catalog or on the web. Every effort has been made to ensure the accuracy of the catalog and web material. However, we assume no liability for errors or omissions from any source.

Contract: The management, auctioneers, and employees act as agents for the seller, but assume no liability for either the buyer or the seller. Any representations made by the sales management are made on behalf of the seller.

The above terms and conditions shall constitute a contract between the buyer and the seller of each animal sold. All guarantees are between buyer and seller.

Health: The EIA/Coggins test will be less than 3 months old. Current health papers for transportation will be good for 7 days past sale date. Proof of pregnancy from a veterinarian is required for bred jennets, otherwise sold as exposed. **Buyers are responsible to obtain the paperwork they need from the veterinarian after payment immediately following the Sale.**

Transport: We may be able to help you get your donkey(s) home. Please let us know if you may need this assistance.

Export: Export buyers will assume all related export costs such as veterinary work, quarantine, shipping, etc. For further clarification, contact us, we export frequently.

General: Please note that information in the catalog has been provided by the consignors. Height data may be birth, immature or adult registered heights and are included only as helpful data. All donkeys will be measured in public view on Friday at the time shown on the schedule. We encourage you to personally inspect the donkeys you are interested in and / or talk with or contact the consignors.

Absentee / Phone Bids

Please contact Dowell or Martha Howard at 513-398-3341, 513-225-1771, or 513-919-5613, or email at mhoward@eos.net by the Wednesday before the Sale

Please Bring This Catalog – Supplies Are Limited

The Great American Miniature Donkey Sale

Camping & Lodging

Camping: Camping available at the Fairgrounds for \$20. Water & electric hook-ups, dump station, restrooms & **HOT** showers. 250 ft from the Sale. Pay Martha.

Motels & B&B

Motel	Miles from Sale	Address	Phone	Web
Lebanon				
The Golden Lamb	1	27 S Broadway	513-932-5065	goldenlamb.com
Shaker Inn	2	600 Cincinnati Av.	513-932-7575	shakeinnmotel.com
Hatfield Inn B&B	5	2563 Hatfield Rd	513-932-3193	bbonline.com/oh/hatfield/
Mason (I-71, Exit 25 - Rt 741)				
Kirkwood Inn	9	4030 S US Rte 42	513-398-7277	kirkwoodinn.com
Super 8 Motel	9	5589 Kings Mills Rd	513-398-8075	super8.com
Hampton Inn	9	5323 Beach Blvd	513-459-8900	hamptoninn.com
Comfort Suites	9	5457 Kings Center Dr.	513-336-9000	comfordsuites.com
Baymont Inn	9	2793 WaterPark Dr.	513-459-1111	baymontinn.com
Microtel Inn Suites	9	5324 Beach Blvd	513-754-1500	microtelinn.com
Mason (I-71, Exit 19 - Fields Ertel Rd)				
Days Inn	15	9735 Mason Montgomery	513-398-3297	daysinn.com
Red Roof Inn	15	9487 Bardes Rd	513-398-3633	redroof.com
Hyatt Place	15	5070 Natorp Blvd.	513-754-0003	hyattplace.com
La Quinta	15	9918 Escort Drive	513-459-1111	lq.com
Marriott	15	9664 Mason Montgomery	513-459-9800	marriott.com
West Chester (I-75, Exit 19 - West Chester)				
Marriott	17	6189 Mulhauser Rd	513-874-7335	www.marriott.com
West Chester (I-75, Exit 22 - Tylersville Rd)				
Wingate Inn	14	7500 Tylers Place Blvd	513-777-1101	www.wingatehotels.com
Monroe (I-75, Exit 29 - Rt 63)				
Howard Johnson	8	150 New Garver Rd	513-539-9221	www.hojo.com
Comfort Inn	8	120 Senate Dr	513-539-2660	www.comfortinn.com
Hampton Inn	8	40 New Garver Rd	513-539-4400	www.hamptoninn.com

Elms Farm Miniature Donkeys

We strive to produce quality miniature donkeys with excellent conformation, great dispositions and personalities

- * **Correct, drafty donkeys - sorrels, blacks, darks, spots & woollies**
- * **Large sorrel herd, one of the most genetically diverse anywhere.**
- * **Herd Sires - Sorrels, Blacks, Spots, Woollies**
- * **Every foal carries sorrel or black genes or both.**
- * **Breed stock selected from herds across North America**
- * **Each mating planned to strengthen desirable characteristics.**
- * **Foundation Herd Planning – Export Expertise**
- * **'Shipping Around the Corner or Around the World' SM**

2010 Consignor List

Arcadian Exotics, Paul and Gertrude Suorsa, 133 Branchton Rd.
Slippery Rock, PA 16057, 724-794-3288, c 724-556-9940,
ggsuorsa@embarqmail.com
Lots 18 & 32

Assphalt Acres, Steve and Jill Crim, 3640 N 775E, Manilla, IN 46150,
765-544-2567, c 317-402-3958, assphaltacres@yahoo.com,
www.assphaltacres.com,
Lots 7 & 41

Ass-pirin Acres, Marshlyn and Michael Reed, 4241 VT Rt. 17W, Addison, VT
05491, 802-759-2665, minidonk@together.net, www.asspirinacres.com,
Lots 4, 13, 17, 31, & 43

Continental Farm, Wayne and Joan Schuetz, 804 SE 11th St., Washington,
IN 47501, 812-254-0811, c 812-486-6809, continentalfarm@yahoo.com,
www.continentaldonkeys.com
Lots 10, 30 & 37

Elms Farm Miniature Donkeys, Martha and Dowell Howard, 5600 Bethany
Rd., Mason, OH 45040, 513-398-3341, c 513-225-1771, c 513-919-5613,
mhoward@eos.net, www.donkeys.net,
Lots 1, 6, 11, 19, 24, 29, 35A, 35B, 35C, & 46

Gold Mine Farm, Jerry and Barb Persinger, 235 Caravella Court,
Livingston, TX, 77351, 936-328-0474, c 936-328-0474, jpersinger4@aol.com,
www.goldminefarm.com,
Lots 12, 26 & 40

Heiken's Ark, Dick and Kathy Heiken, PO Box 35456, Des Moines, IA 50315,
515-962-0667, c 515-360-5911, heikensark@aol.com, www.heikensark.com
Lots 8 & 34

Hill Country Miniatures, Ed and Angela Preston, 339 E. Town East Blvd.,
Sunnyvale, TX 75182, 972-226-6386, c 817-729-7700,
draughonpreston@aol.com, www.hillcountryminiatures.com,
Lots 2,9, 20, 28, 36, 42

Hill's Haven, Bill and Sue Hill, 3305 203rd St., Fort Madison, IA 52627,
319-372-3539, hillshaven@q.com, www.hillshavendonkeys.com,
Lots 15

Ledge End Farm, Naomi St. Julian, 17285 Sidney Freyburg, Botkins, OH
45306, 937-693-7505, c 330-256-2206, donks@honkydonk.net,
www.honkydonk.net
Lots 22 & 44

2010 Consignor List

Mini Moons Ago Miniatures, Tammy Jo McCleney 1142 P.R. 8025,
Paige, TX 78659, 512-848-6575, minimoonsagodonkeys@earthlink.net,
www.minimoonsago.com
Lots 3 & 38

Old Lawson Farm, Mike and Annie Kearney, 1745 W. Lawson Rd.,
Bloomington, IN 47404, 812-876-6751, c 812-219-3107,
mikekearney5@hotmail.com
Lot 23

Ravenwood Farm, Jerry and Susie Patterson, 6128 S 1100 W,
Hartsville, IN 47244, 812-546-6128, c 814-614-4451, c 812-614-4019,
donkeys@directv.net, www.ravenwoodfarm.com
Lot 16

The Red Gate, Scott and Theresa Ellinger, 14677 Dutch Cross Rd.,
Centerburg, OH 43011, 740-625-9092, c 740-281-9570,
www.theredgate@axom.com
Lots 14 & 45

TTW Thistledown Acres, Tim and Tara Walworth, 5N919 Fabris Rd.,
Maple Park, IL 60151, 630-365-0921, tara@TTWdonkeys.com,
www.ttwdonkeys.com
Lots 21, 25 & 39

West Prairie Farm, Gene and Betty Willmann, 5455 West Prairie Dr.,
Belleville, IL 62220-5001, 618-235-0221, c 618-578-9676,
genewillmann@sbcglobal.net, www.westprairiefarm.com.
Lots 5, 27 & 33

NMDA Silent Auction Benefit

There will be a Silent Auction for the benefit of the National Miniature Donkey Association (NMDA) Gelding Fund. Your donations and support to benefit this worthy endeavor are appreciated. Cash or check donations are also appreciated. The NMDA is a charitable organization; your donations may be tax deductible. Please contact Edith Thomas, 740-852-7608, halfasst.acres@yahoo.com for more details.

5 *West Prairie Josea*

Black Jennet, 7/19/08, Reg. #56769

Consignor: West Prairie Farm, 32.75" March 2010

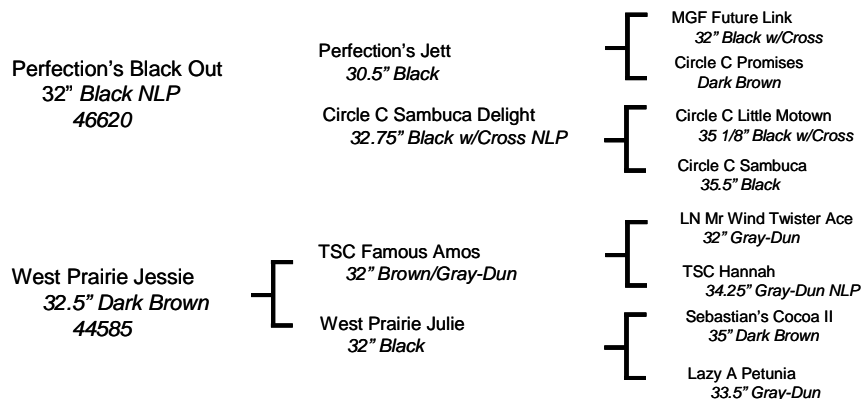

Great, full pedigree top and bottom. This 2 year old is true black, very gentle, and loves attention. She has some great sires and dams in her background. Her mother has produced very good offspring for us. She will be a great dam based on the breeding behind her. Take a good look at Josea.

6 *The Elms Lady In The Mist*

Dark Brown & White Spotted Jennet, 5/25/09, Reg. #59310

Consignor: Elms Farm Miniature Donkeys, 20.75" at Birth

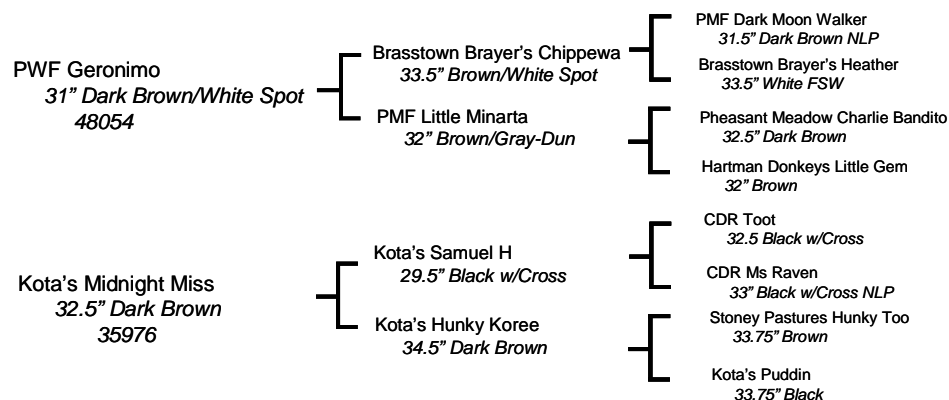

Lady's an elegant jennet with a lot of good stuff behind her. Geronimo has been a jennet producing sire. Very pretty jennet with bold spots. Sweet and correct, take a good look at Lady in the Mist!

7 *Assphalt Acres Peaches*

Dark Red Jennet, 4/19/09, Reg. #59296

Consignor: Assphalt Acres, 27" March 2010

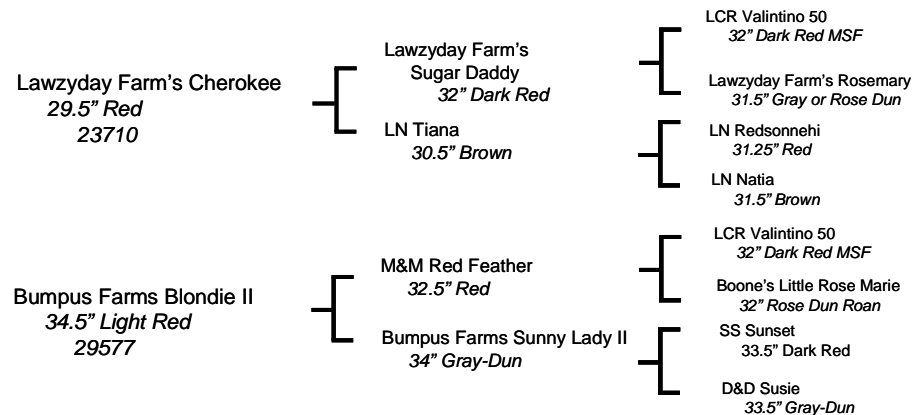

Peaches is a nice dark red yearling jennet that has it all. She is well balanced, has a very pretty head, very good conformation and a nice round rump. She is by Lawzyday Cherokee, a 29.5" red jack, so she should mature very small and very correct. Add this girl to your sorrel herd and you won't be sorry.

8 *Heiken's Ark Valerie D*

Brown & White Spotted Jennet, 8/21/09, Reg. #Pending

Consignor: Heiken's Ark, 20.75" at Birth

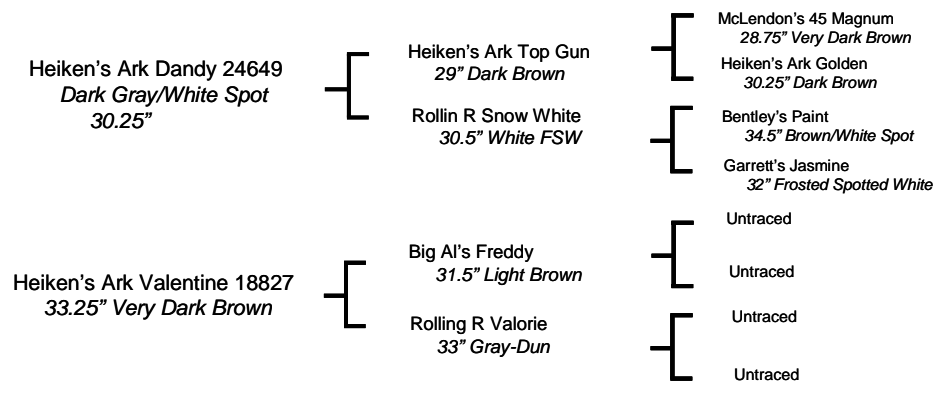

Valerie D is a flashy spotted jennet. She really catches your eye in the pasture. She carries herself proudly and challenges you to pay attention to anyone else with her antics. She will make a great addition to any herd.

9 Hill Co Mini's Prada

Very Dark Brown Jennet, 3/6/09, Reg. #57020
Consignor: Hill Country Miniatures, 27" at 1 Year

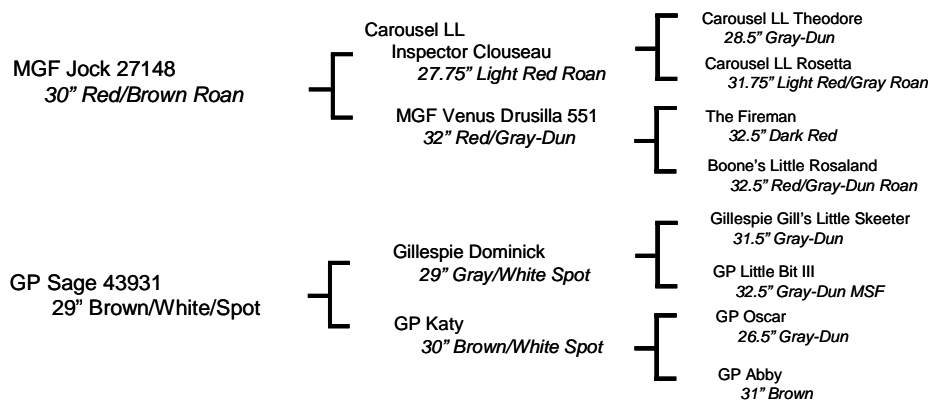

Hill Country Miniatures Prada will be a very short, very stocky jennet with heavy bone, an extremely wide chest, huge hip, and a beautiful short head. She is perfect for anyone who wants a very short, but full bodied jennet.

10 Continental Naomi

Red Jennet, 8/24/08, Reg. #56301
Consignor: Continental Farm, 32" May 2010

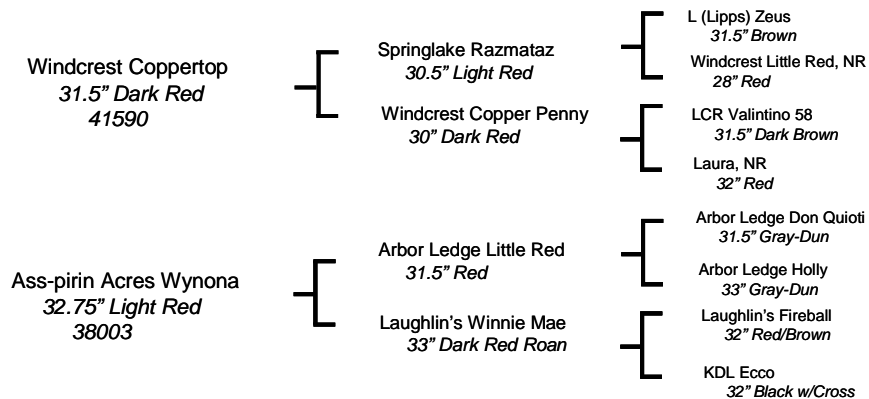

If you liked Ashley last year, you'll love Naomi. It's a repeat breeding. How sweet she is! Naomi has the look of sifted confectioners sugar over her beautiful red body. Her dark red color with the strong white contrast will make her a show ring delight. You'll appreciate Naomi's great conformation from near or far. She will surely add color to your herd when you purchase this sweet treat.

11 Merry-Go-Round's Pebbles

Dark Red Jennet, 7/17/01, 31.5" Reg. #31079, Bred for 2011
The Elms Rockford
Dark Red Jack Foal, 5/3/10, 22" at Birth, Reg. #59368
Consignor: Elms Farm Miniature Donkeys

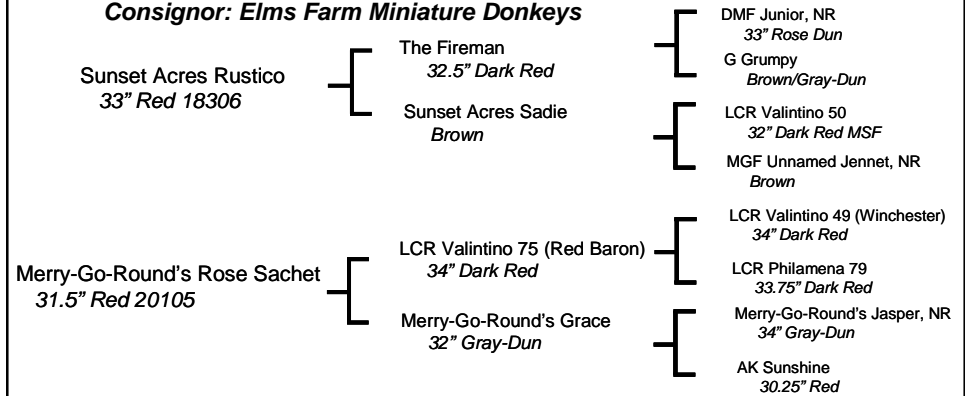

Pebbles has had 3 very nice small, dark red jennets, one remains in our herd. She has what everyone wants in a small dark red breeding jennet. Her pedigree is full of wonderful red jacks, and to top it off, she has a foal at her side, The Elms Rockford, sired by Santana. Pebbles is bred back to our next generation dark red Herd Sire, The Elms That's Amore, a Santana son. Don't miss this great 3 in 1 package!

12 B. J. Patty Lou

Red, Gray & White Spotted Jennet, 8/1/09, Reg. #Pending
Consignor: Gold Mine Farm, 20.5" at Birth

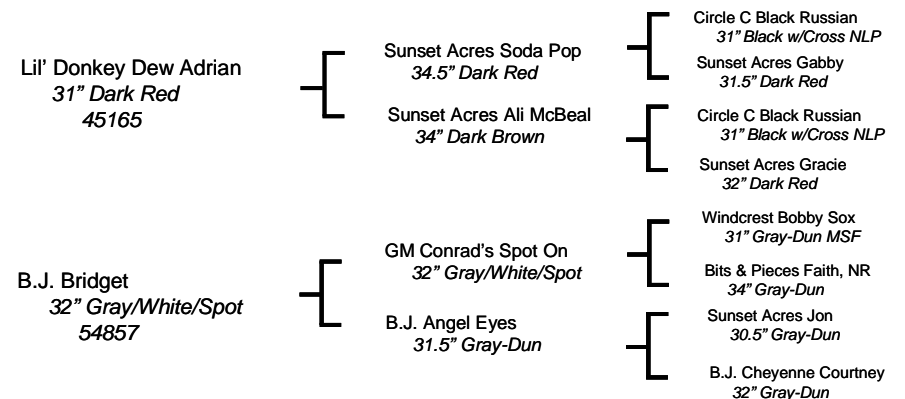

B.J. Patty Lou, Texas born, is a frosted white. Her full pedigree is awesome, along with her well built body that has quality and balance. She is always ready for a hug and a treat. Take a look at her and you will want to take her home with you.

13 Ass-Pirin Acres *Pala*

Dark Red Jennet, 5/27/09, Reg. #Pending

Consignor: Ass-Pirin Acres, 29.25" March 2010

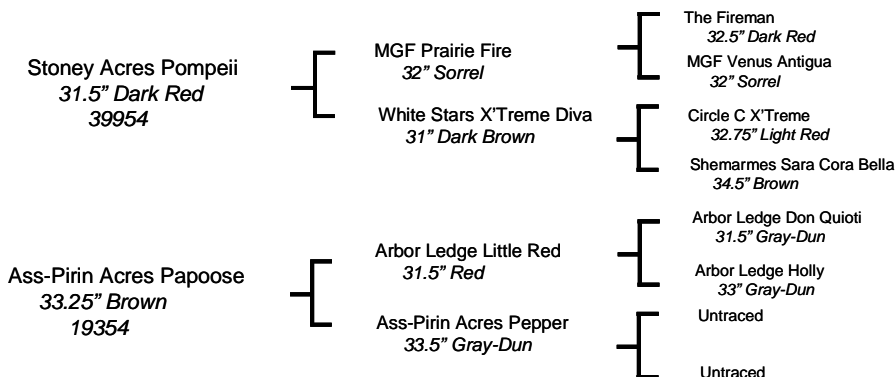

Pala is up headed, showy and has correct conformation as well. Her "look at me" personality will make her stand out in your herd. Her rich dark red coat is another plus. Get the whole deal with this jenny.

14 The Red Gate's *Silver Rose*

Gray-Dun Jennet, 4/16/06, 31" Reg. #47061, Bred for 2011

The Red Gate's *Bit O'Precious*

Gray-Dun Jennet Foal, 10/12/09, 20.5" at Birth, Reg. #Pending

Consignor: The Red Gate

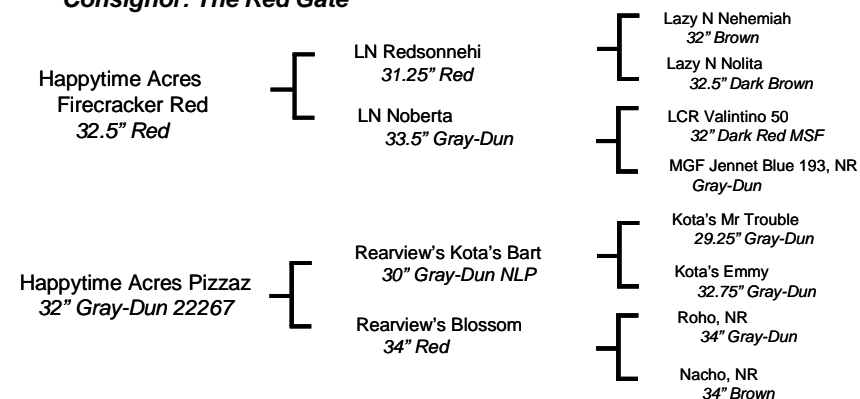

WOW! Two jennets! Silver Rose is fancy, small, and has a gorgeous silvery-rose color & beautiful build. She has a superb pedigree with red color and small sizes. 'Bit' is her first foal, sired by Red Gate's Branson (30" dark brown grandson of 2004 ADMS National Halter Champion W.C. Luigi). Silver Rose is in foal to WFF Hollywood Hype, a 30" frosted spotted heavy boned white jack.

15 Hill's Haven *Shakira*

Dark Red/Brown Jennet, 6/12/09, Reg. #57130

Consignor: Hill's Haven, 22" at Birth

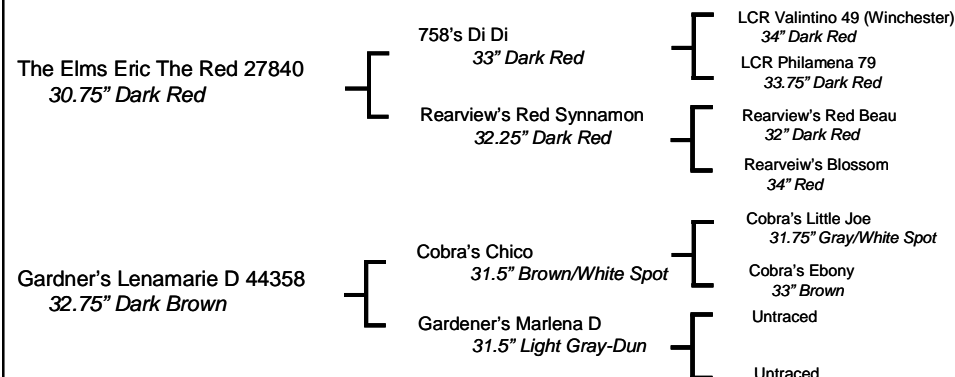

Shakira has a varied color background, from dark brown from her dam to well known spots of Cobra's Chico and Cobra's Little Joe. She has beautiful reds of The Elms Eric the Red to 758's Di Di on back to the famous Rearview's Red Beau. She should throw the colors that you prefer and enjoy.

16 KiTerra's *Salsa Dancer*

Dark Brown Jennet, 3/14/06, Reg. #47327

Consignor: Ravenwood Farm, 31.75", Bred for 2011

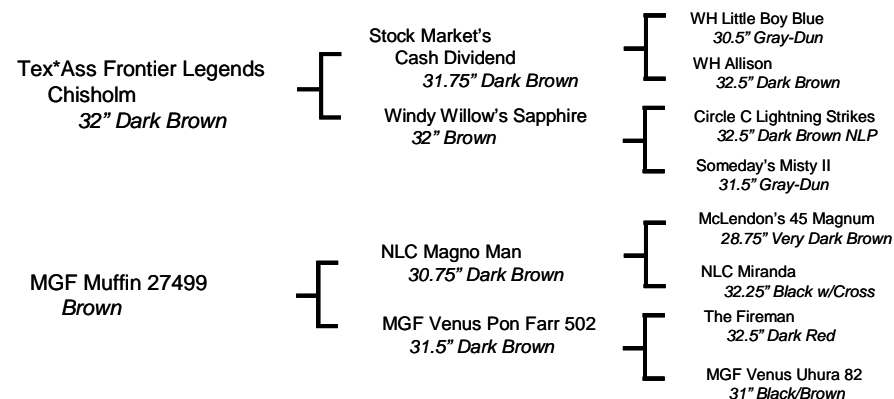

Salsa is a beautiful, small stocky jennet sired by ADMS National Supreme Champion Sire FL Chisholm. Her pedigree includes Red Lightning, Fireman and Magnum. She is bred for a 2011 foal to Cherries Jubilee, a proven red producing jack. This is a great 2 in 1 package.

17 Ass-Pirin Acres *Miss Gabor*

Black/Brown Jennet, 5/21/09, Reg. #Pending

Consignor: Ass-Pirin Acres, 30.25" March 2010

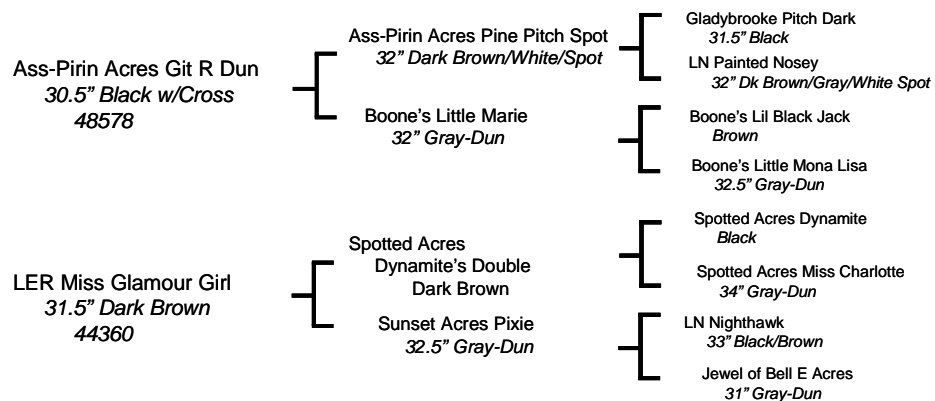

Miss Gabor is the result of great genetics featuring Ass-Pirin Acres, LER, LN, Boone's, Sunset Acres, Bell Acres, etc. She is showy with her up headed personality, but has a great loving disposition. Lots of spots behind her also. How ever you breed her, she will be an asset to your herd.

18 Arcadian *Brettina*

Black Jennet, 6/5/08, Reg. #Pending

Consignor: Arcadian Exotics, 31.5" March 2010

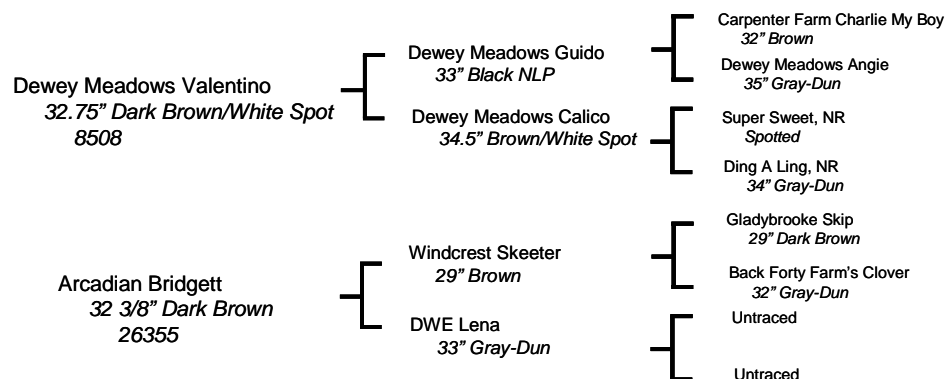

Brettina is sired by our senior jack, Dewey Meadows Valentino. He has sired many outstanding foals sold in previous sales. This 2 year old jennet has inherited his black genes. She has good body and leg conformation and will soon be ready to breed to your jack.

19 The Elms *Little Pearl*

Dark Brown & White Tyger Spotted Jennet, 5/31/09, Reg. #57177

Consignor: Elms Farm Miniature Donkeys, 31" June 2010

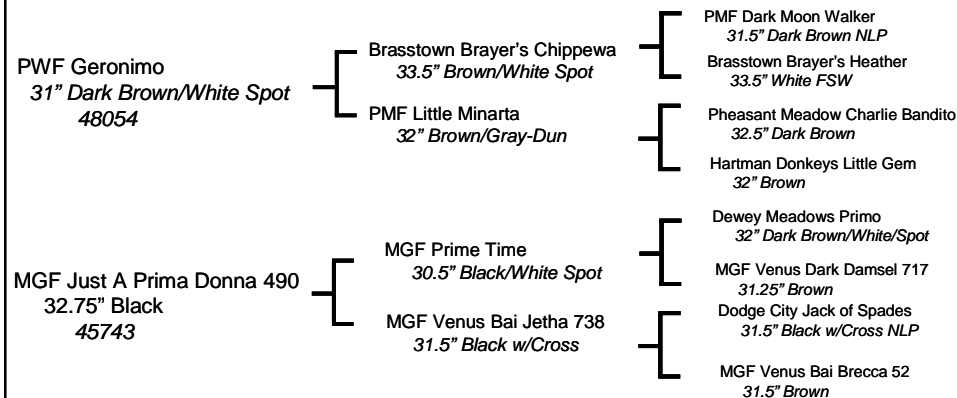

A precious Little Pearl! Special since birth, she is maturing to be a gorgeous jennet. Mostly white, with tyger spots, she has great legs, a round rump, very pretty head, and a willing temperament. We should be keeping this Geronimo daughter.

20 Hill Co Mini's *Solstice*

Black w/Cross NLP Jennet, 11/7/08, Reg. #55143

Consignor: Hill Country Miniatures, 21" at Birth

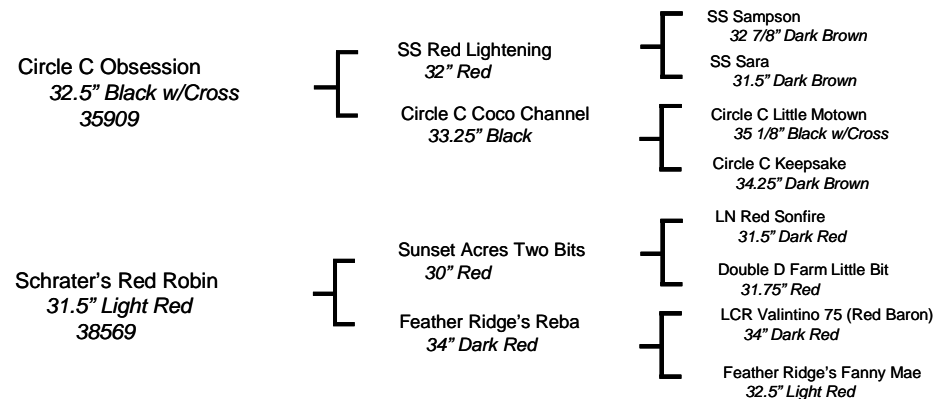

Hill Country Mini's Solstice is a very well balanced, stocky show jennet. She is the daughter of a World Champion black jack, Circle C Obsession, and an elegant refined red jennet. She is extremely correct, with a short head, big rump, short back, and great leg set. Her pedigree is loaded with notable donkeys. She can produce red or black babies.

21 TTW *Valentino 50th's Waka Blue*

Dark Brown/Black Jennet, 6/2/09, Reg. #59158
 Consignor: TTW West Winds, 28" May 2010

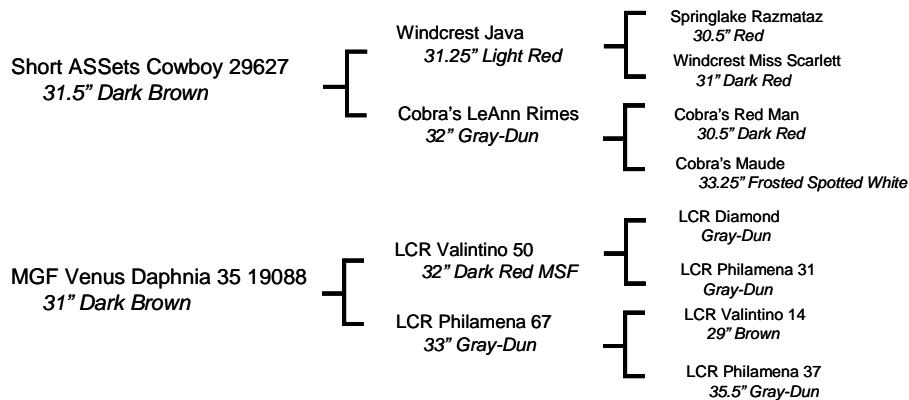

Waka is a well balanced dark beauty, whose pedigree includes multi champion Windcrest Java, Cobra's Red Man, and Valentino 50th. She might produce brown, black or red foals given her genetics. She has a full 4 generation pedigree on both sides, a rare offer!

22 *Legendary Fanny*

Dark Brown/Gray-Dun Jennet, 10/31/07, Reg. #54095
 Consignor: Ledge End Farm, 33" March 2010

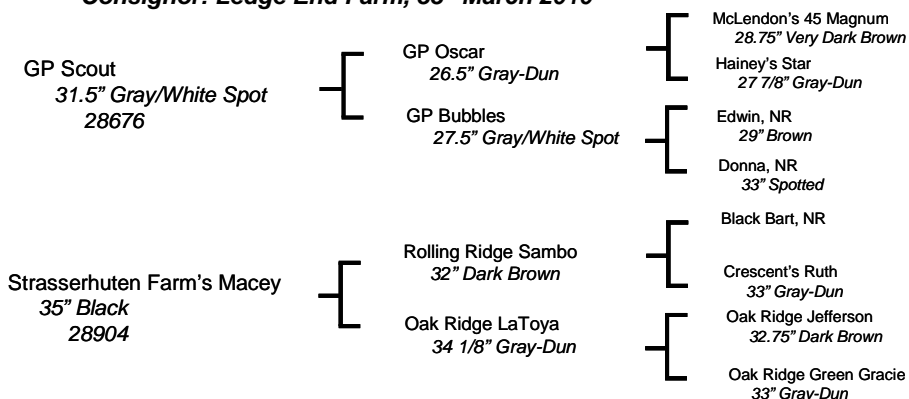

Fanny really stands out from the herd. Even as a foal, she expected our attention. No shrinking violet here! Fanny has matured into a sweet, well-behaved jennet with a lovely medium brown coat, well muscled body, straight legs and lots of style. Her sire is gray/white spot, and her dame is black (no cross) with a star. She has good, strong qualities you look for in breeding stock with emphasis on a winning disposition. She will be a great addition to your herd.

23 *Perfection's Honey Nut*

Dark Brown Jennet, 10/28/05, Reg. #46625
 Consignor: Old Lawson Farm, 33.25", Bred for 2011

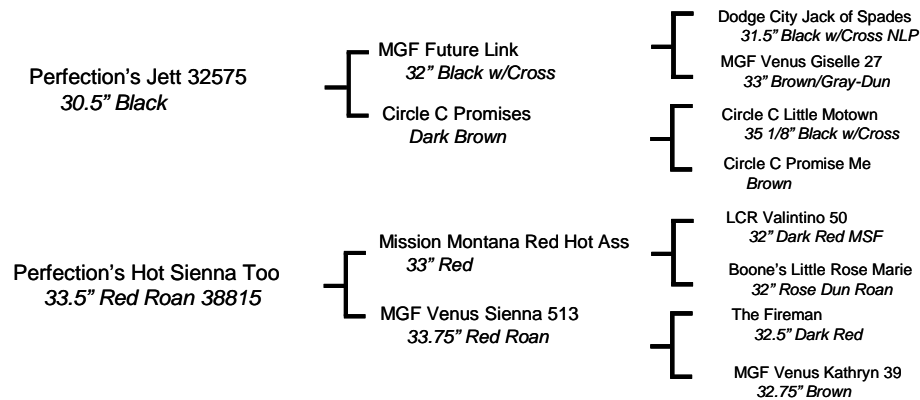

Cross a Red Hot daughter with Perfection's Jett and you'll get a Honey Nut! Her maternal line traces back to the legendary Venus Kathryn 39. She's bred to Hill Country Miniature's Liberty, a stocky, correct, coal black jack that was Grand Champion and Model Donkey at the Texas State Fair in 2003 (Miller's Mr Spock X Someday's Feliciano). Don't pass her up!

24 *Merry-Go-Round's Silhouette*

Black NLP Jennet, 7/14/04, 33.75" Reg. #40681, Bred for 2011

The Elms Swashbuckler

Black w/Cross Jack Foal, 5/22/10, 22" at Birth, Reg. #Pending
 Consignor: Elms Farm Miniature Donkeys

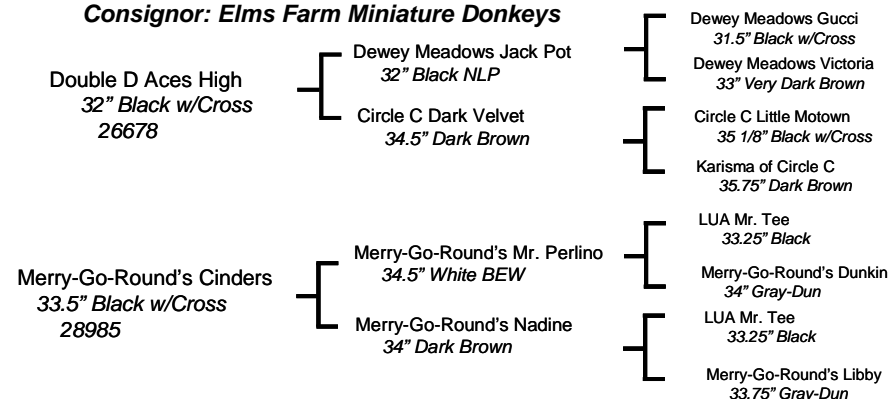

Dreaming of the ultimate black donkey? Look no further! Perfectly named, Silhouette is always an intense black, no fading. Gentle, with a beautiful head, wide chest, and correct build, she is Splendid! Great full, diverse pedigree. At her side is The Elms Swashbuckler, by Musketeer. The foal is black, with white nose, belly and eye rings for flashy contrast. He has good bone, and is a woolly carrier. Silhouette will be bred back for 2011.

25 **TTW Tallahassee**

Dark Brown Jennet, 7/5/08, Reg. #55375
Consignor: TTW West Winds, 31.25" May 2010

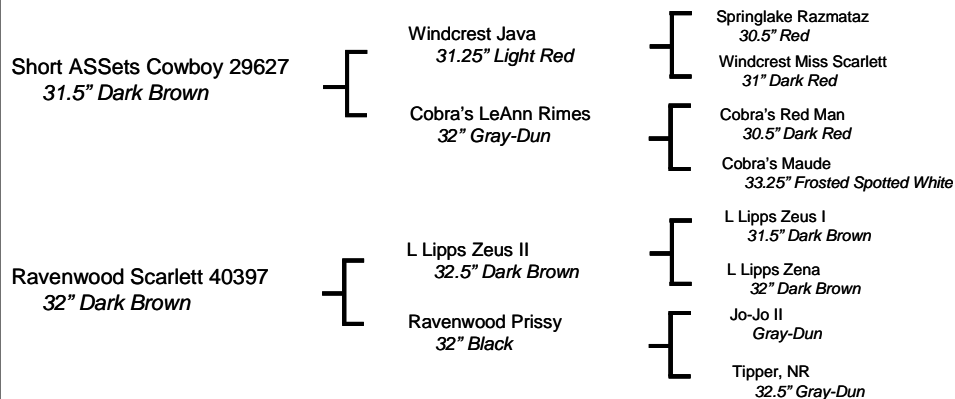

Tally has the most solid conformation I have ever seen. This 2 year old is perfectly square, with width between her legs and a short back length. Proportion makes a donkey healthy and hearty. She is a true specimen of the breed with a known 3 generation pedigree.

26 **B.J. Monique**

Gray & White Spotted Jennet, 10/15/09, Reg. #Pending
Consignor: Gold Mine Farm, 20" at Birth

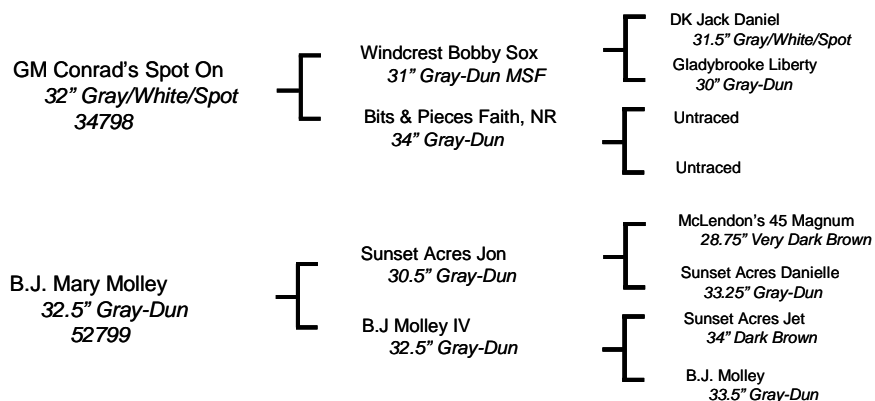

Monique, a Texas gal, is a sharp jennet with a head, body, and legs that says, 'SHOW ME'. She is a real love bug. You will want to take this little gal home to see what she can do for you.

27 **West Prairie Jane**

Black Jennet, 10/30/08, Reg. #Pending
Consignor: West Prairie Farm, 32" March 2010

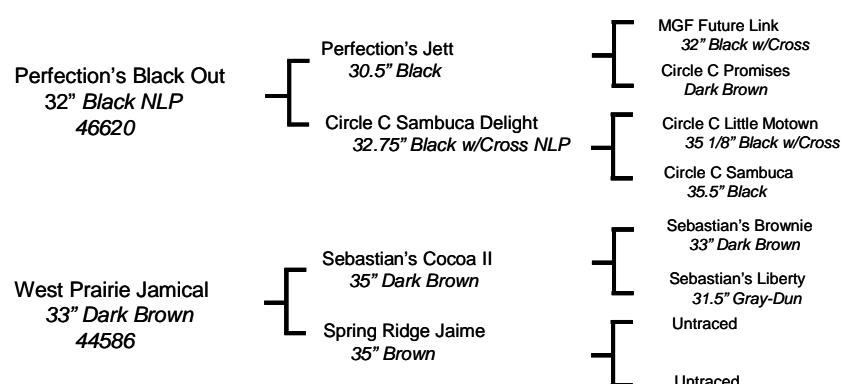

Jane has a great pedigree on both sides. Her sire has a Circle C back ground. She has beautiful long ears, a great head, body, legs and feet. Jane loves attention, is very gentle. Her mother, West Prairie Jamical, has had 5 jennies in a row. Jane should be a nice addition to almost any herd.

28 **Cedar Creek Foxy Lady**

Brown Jennet, 2/7/05, Reg. #42077
Consignor: Hill Country Miniatures, 32.5", Bred for 2010

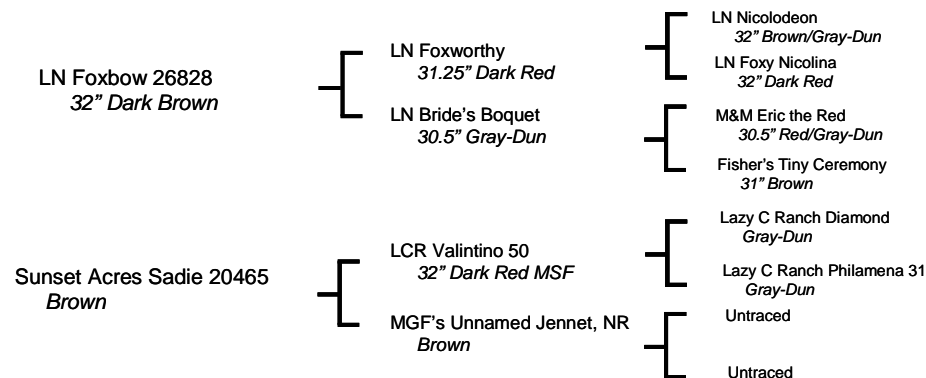

Cedar Creek Foxy Lady is a brown jennet with a beautiful head, and a pedigree loaded with well known donkeys. She has elegant lines, a thick body, and a big hip. She is bred to National Champion Halter Jack Hill Country Miniatures Poquito for a late fall 2010 foal.

29 The Elms *La Reine Helene*

Black w/Cross Jennet, 4/19/09, Reg. #57180

Consignor: Elms Farm Miniature Donkeys, 22" at Birth

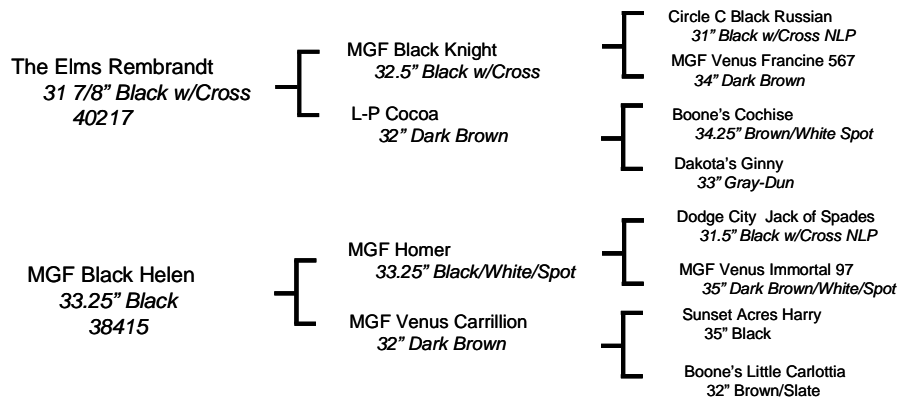

She walks in beauty, like the night! Helene is regal, like the queen she is. She is black with a white belly and white points like her sire, The Elms Rembrandt. Stocky and straight. She is sure to be a favorite on your farm!

30 LN *Glo Doug*

Dark Red Gelding, 12/8/04, 34" Reg. #56304, Harness Trained

LN *Glo Sam*

Dark Red Gelding, 8/6/05, 33.5", Reg. #56305, Harness Trained

Consignor: Continental Farm



LN Glo Doug is out of LN Neadella (sired by LN Redsonnehi, out of LN Della Dee)

LN Glo Sam is out of LN Red Star (sired by LN Red Sonfire, out of LN Neadella)

You'll be the talk of the town in your Doctor's Buggy. These two 5 year old geldings have been professionally trained to work single or as a team. The harness and Dr's Buggy are Amish made. The deep mahogany with the white markings of the pair makes for a striking presentation. The classy looking buggy is forest green with a beige top. The harness is black with lots and lots of Bling (silver spots).

31 Ass-Pirin Acres *Fancy That*

Dark Brown & White Spotted Jennet, 8/23/09, Reg. #Pending

Consignor: Ass-Pirin Acres, 22" at Birth

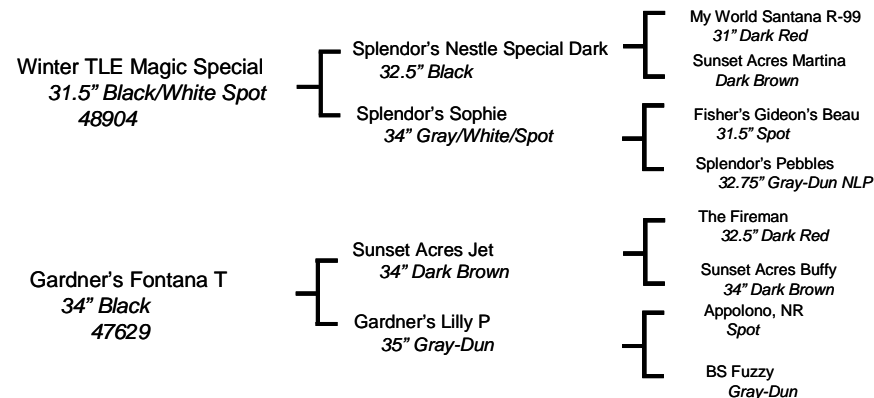

Fancy she is! Great Conformation. She is a drafty, well boned, solid jenny. Fancy could do it all. Show her now and enjoy her wonderful foals when she matures. Fancy has a sound mind and body. This is a spot that will make you proud no matter what you decide to do with her. She is a super people friendly little girl.

32 Arcadian *Adell*

Dark Gray NLP Jennet, 4/5/09, Reg. #Pending

Consignor: Arcadian Exotics, 31" March 2010

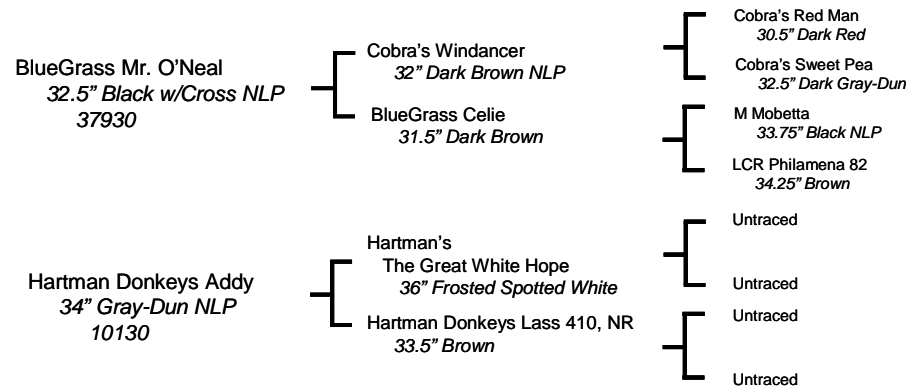

Adell is a great young jennet with a steel gray points, black face and muzzle, no light points. Her sire is our young black jack, BlueGrass Mr O'Neal. He goes back though some excellent Cobra breeding, red on the upper side carried by Windancer, going back to Arthur II, and Arthur. Mr O'Neal traces through Celie to Circle C Little Motown.

33 West Prairie Anna

Brown Jennet, 12/19/08, Reg. #Pending
 Consignor: West Prairie Farm, 30" March 2010

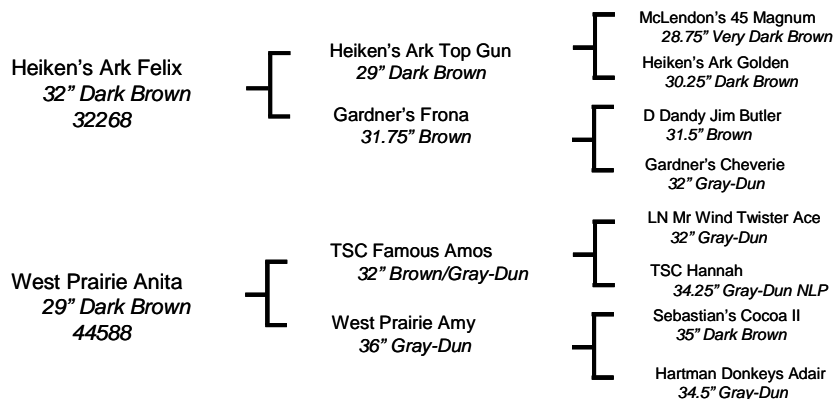

Anna has great pedigree on the top and bottom. Her sire, Felix, is a son of Top Gun, only 29" tall. Her mother is also the same 29" height. She has all the features for a great little jenny. She will have black or brown offspring depending on the jack's color. She'll be 18 months old at Sale time and will make a great jenny for most herds.

34 Heiken's Ark Lisha LB

Black Jennet, 9/21/09, Reg. #Pending
 Consignor: Heiken's Ark, 20.25" at Birth

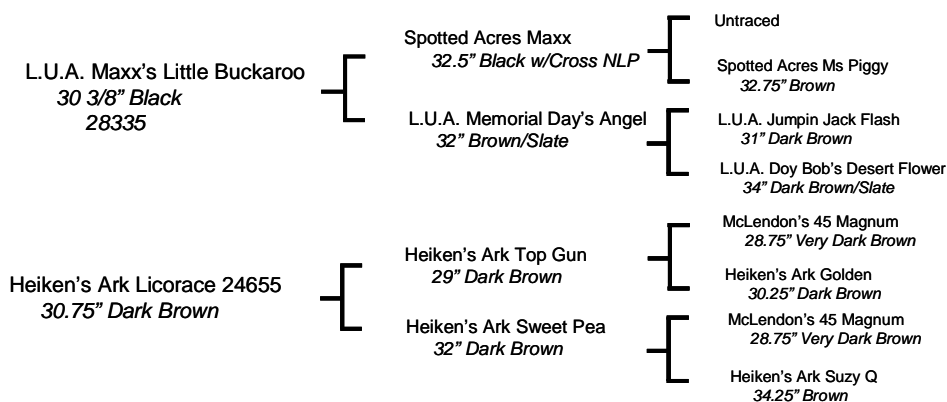

Lisha LB is a super young jennet with a black foal coat. She gets her color and conformation from her sire. Her dam is a Magnum grand daughter and Lisha has inherited some of his traits. She is just a great little jennet.

35A The Elms Red Hot Rudy

Lot 35 Sells As Choice

Dark Red Jack, 6/27/08, Reg. #Pending
 Consignor: Elms Farm Miniature Donkeys, 31.25" April 2010

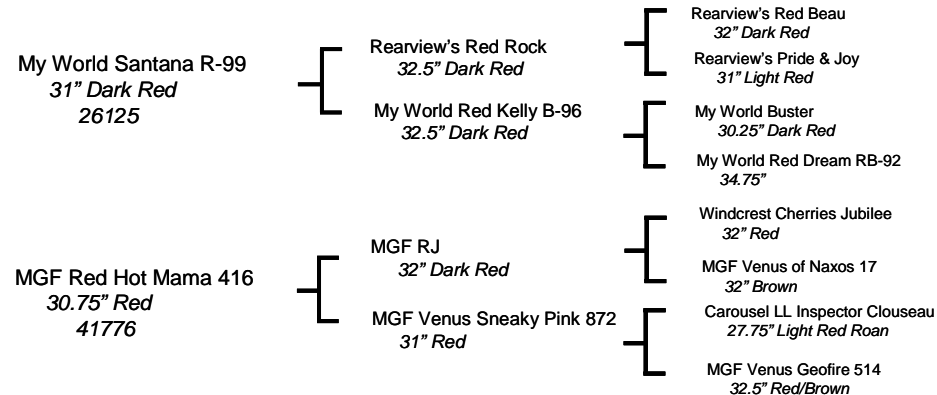

Great build! DNA typed homozygous red, he is a true black cherry red without the extensive white points (frosty roan) so typical of the red donkeys, Rudy is an excellent jack to breed to spots to get the sought after true red and white spot that does not turn frosted white. We may regret offering this fine jack, but you can take him home!

35B The Elms Whistler

Lot 35 Sells As Choice

Dark Brown Jack, 5/11/08, Reg. #Pending
 Consignor: Elms Farm Miniature Donkeys, 31" May 2010

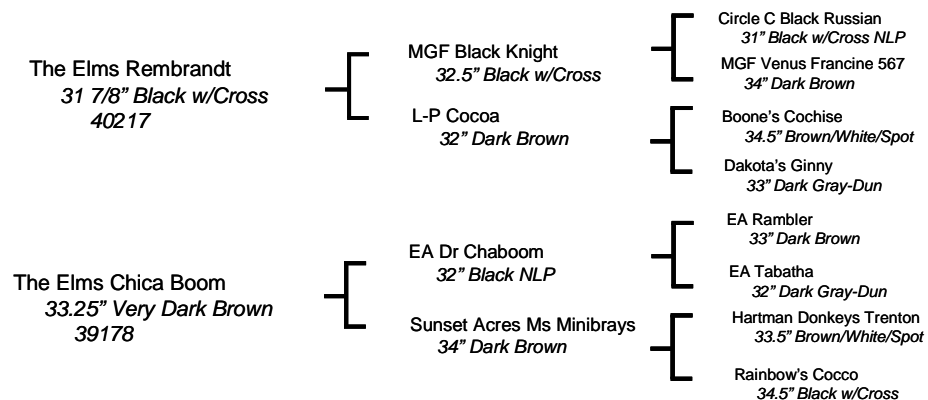

Meet Whistler, who sports a full, diverse pedigree with 2 generations of Elms Farm Breeding. Super straight, stocky, small, good temperament, in the richest shade of dark brown. His sire, Rembrandt, and his grand sire, Black Knight, are known for the exciting foals they produce. Whistler ranks up there in this tradition of excellence. He has started his breeding career here at Elms Farm.

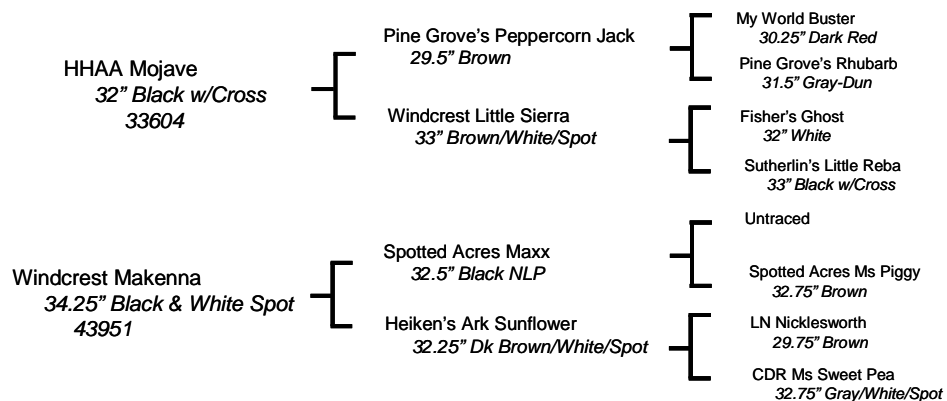
35C**The Elms *Makenna's Gold****Lot 35 Sells As Choice***Black, Brown & White Spotted Jack, May 7, 2009, Reg. #Pending****Consignor: Elms Farm Miniature Donkeys, 21" at Birth**

Outstanding in the field, Makenna's Gold is a second generation tyger spot. He has full black eyeliner, nice straight legs, and a well rounded butt. Jacks like this don't come around often. He is a great prospect to put the good build and the sought for tyger pattern in your spotted breeding program.

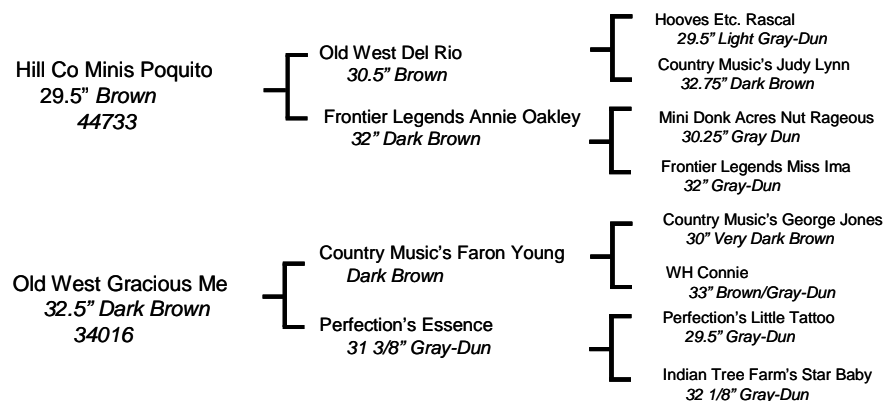
36**Hill Co Minis' *J-Lo*****Dark Brown Jennet, 3/26/08, Reg. #55139****Consignor: Hill Country Miniatures, 30.5" May 2010**

J-Lo is a small stocky jennet with a deep hip, baby doll head, flat top line and beautiful legs. She is the first daughter of our 2008 NMDA National Halter Champion, and her pedigree is loaded with small donkeys from renowned breeders. The first to greet you, she will do well for anyone wanting small & stocky, whether for the show ring or breeding pen.

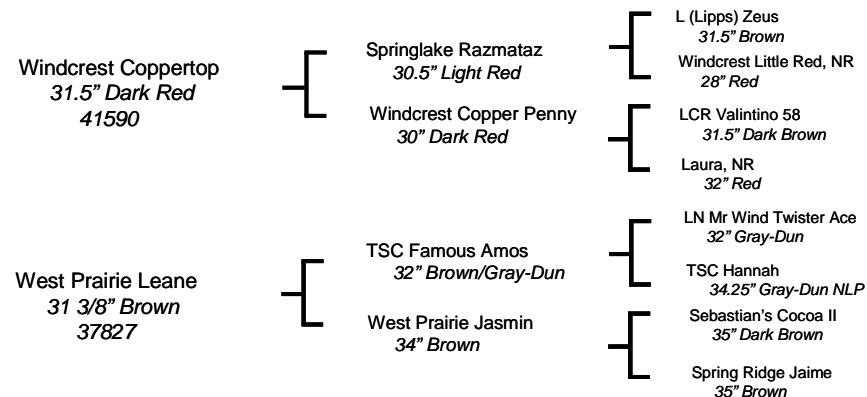
37**Continental *Louise*****Dark Red/Brown Jennet, 5/2/08, Reg. #56302****Consignor: Continental Farm, 31.25" May 2010**

Lovely Louise Looks just Like her Luscious mother, Leane. The written letter "L" is the most gracefully flowing in the alphabet. That seems to describe Louise. West Prairie Leane is the shortest mature jennet in our herd and Louise looks to be following in her footsteps. Forget your ABC's — Look for the "L" — Louise!

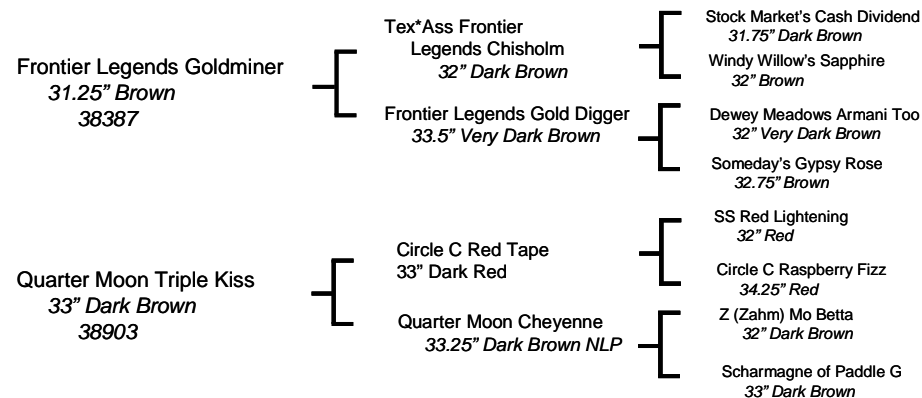
38**Mini Moons' *Kisses of Gold*****Dark Brown Jennet, 11/14/07, Reg. #52870****Consignor: Mini Moons Miniatures, 31.75" March 2010, Bred for 2011**

Kisses is by National Champion and Best of Breed Frontier Legends GoldMiner. Her Dam is Quarter Moon's Triple Kiss... both the sire and dam of Kisses have tremendous Champion pedigrees that will be hard to beat. She is built like a tank. GoldMiner's foals have stayed on the smaller side and I think she will too. A full sister is sorrel, so I exposed Kisses to Big Rivers Red Racer, a beautiful small sorrel jack, for a spring 2011 foal.

39 *TTW Moffit Midori*

Dark Brown/Black Jennet, 8/1/09, Reg. #59162

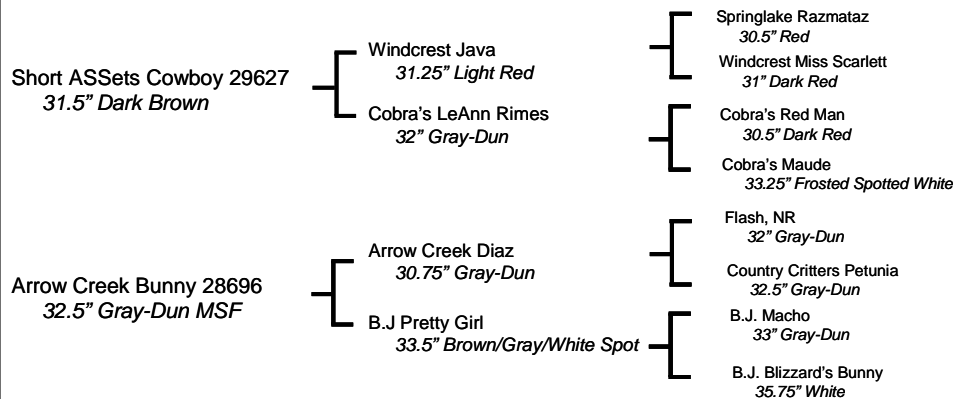
Consignor: *TTW West Winds, 29.5" May 2010*

Moffit comes from Champion show winning stock, Cowboy, Java and Razmataz! There are many respected contributors to red donkey bloodlines in her pedigree (Cobra's Red Man, Windcrest Scarlett) as well as other show winners. Take a good look at Moffit.

40 *B. J. Cleveland Girl*

Brown, Gray & White Spotted Jennet, 7/25/09, Reg. #Pending

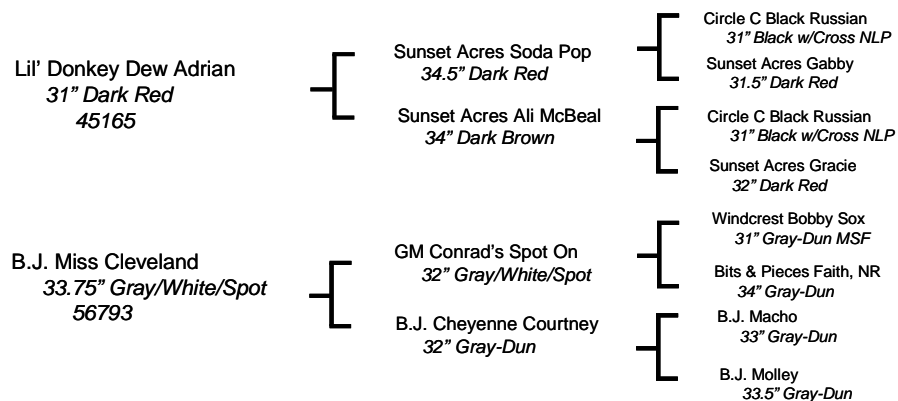
Consignor: *Gold Mine Farm, 20.5" at Birth*

B.J. Cleveland is a true Texas girl, with a long shoulder stripe on her right side. She is a pretty white and gray spot with all the right attributes.... Short, stocky, straight legs and a beautiful head, a nice rear end and a good personality. One look at her pedigree and you will want to add her to your herd.

41 *Assphalt Acres Alison*

Light Red w/ Star Jennet, 4/28/08, Reg. #55953

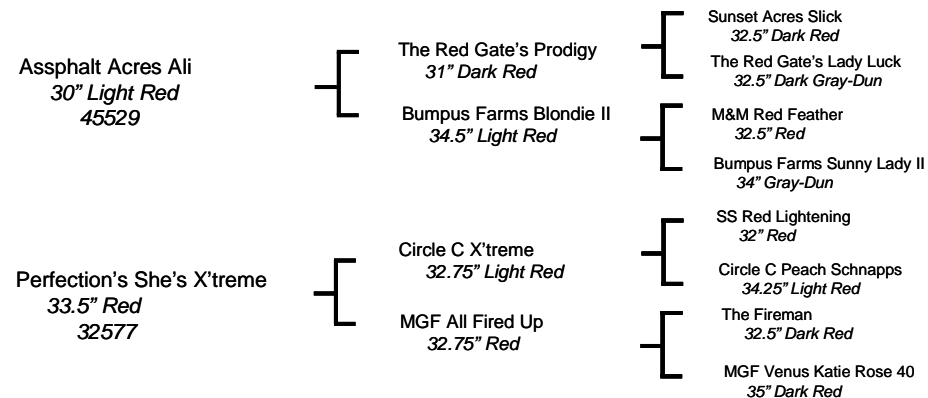
Consignor: *Assphalt Acres, 32.5" March 2010*

Alison is a very correct light red 2 year old jennet by our fantastic 30" herd sire, Assphalt Acres Ali. With Red Gate's Prodigy and Bumpus Farm Blondie II on her sire's side, and Red Lightening & The Fireman as well as Perfection breeding on her dam's side, what more could you ask for? Prodigy was exported to France, so adding Alison to your herd should add a whole new bloodline. Take advantage of our offering here today.

42 *Hill Co Mini's Mocha*

Dark Brown Jennet, 1/25/10, Reg. #Pending

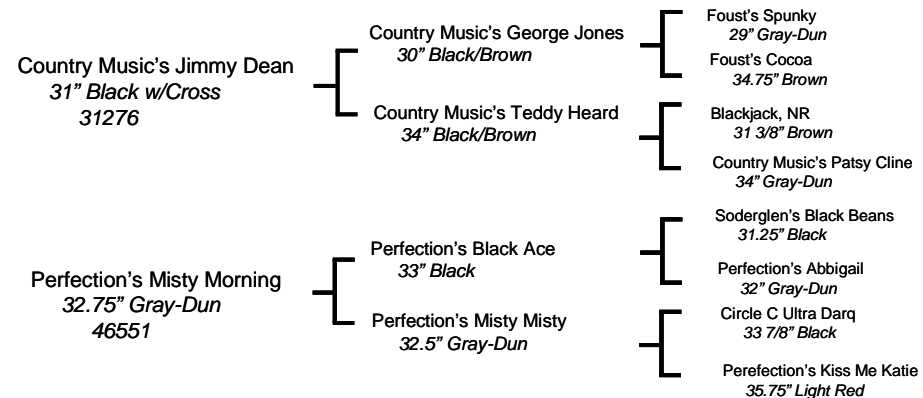
Consignor: *Hill Country Miniatures, 21.5" at Birth*

Hill Country Miniatures Mocha is a super stocky, heavy boned brown jennet with a beautiful head, deep hip, and great balance. She is the daughter of the 2004 NMDA Reserve National Champion Halter Jack, and a gorgeous super stocky 32.75" jennet that we purchased from the Great American Donkey Sale 2 years ago. Mocha has beautiful conformation, a dynamite pedigree, and a willing attitude for the show ring and the breeding pen.

43 Ass-Pirin Acres *Nachina*

Light Red Jennet, 5/10/09, Reg. #Pending

Consignor: Ass-Pirin Acres, 29.5" Feb 2010

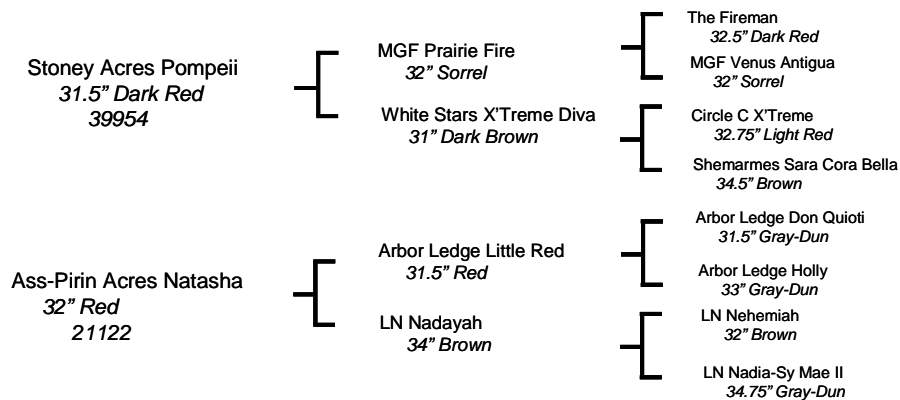

Built the way a donkey should be. Round, wide, good bone, wonderful loving personality. Good show prospect. She should mature around 32" or under. If you want to add quality stock to your breeding herd, take a good look at Nachina!

44 Legendary *Sophie*

Brown Jennet, 8/31/08, Reg. #Pending

Consignor: Ledge End Farm, 32.5" March 2010

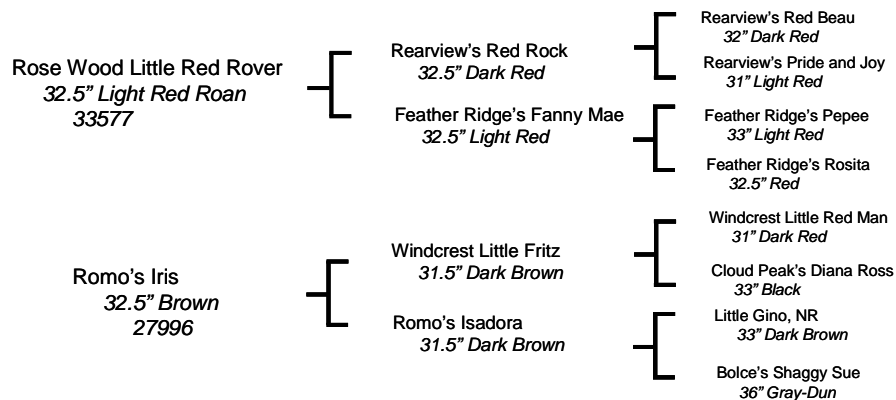

Sophie is a beauty with a super disposition and great attributes. Her sire is a "woolly" light red roan, and she has inherited a longer coat. From birth, she has followed us around and showed outstanding temperament traits. She also inherited her dam's curiosity and is always aware of anything new in the barn or pasture. She has a nice wide chest, and is stocky and straight with a good back line and round hip. Sophie is sure to enhance your breeding program.

45 The Red Gate's *Lilly*

Brown Jennet, 4/13/06, 33.5" Reg. #37142, Bred for 2011

The Red Gate's *Lilly Bouquet*

Brown Jennet Foal, 9/24/09, 22.5" at Birth, Reg. #Pending

Consignor: The Red Gate

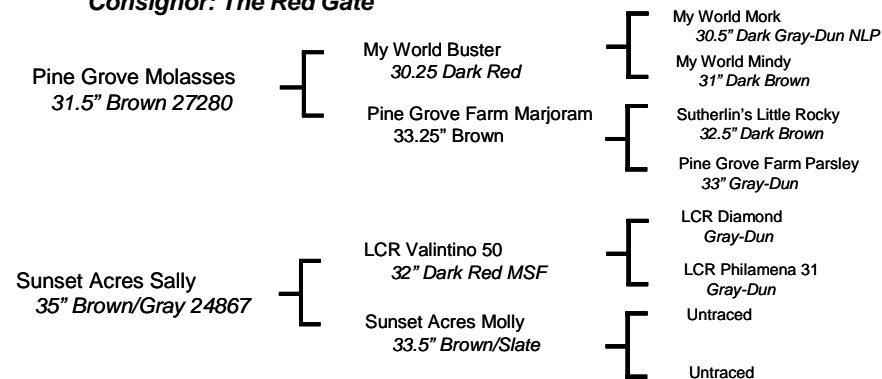

Lilly's an exceptional jennet; right size, build, & proven pedigree. She's solid, with a round rear, wide legs, perfect bite, beautiful head, kind eye & alert look. She's had 2 correct, high selling jennets. Lilly B's sire is The Red Gate's Branson, grandson of 2004 ADMS National Halter Champion W.C. Luigi. Lilly's bred for 2011 to Big River's Red Racer, a red jack, a spectacular 3 in 1 package.

46 KDL *Pimento*

Red Roan Jennet, 3/28/99, Reg. #36235

Consignor: Elms Farm Miniature Donkeys, 33", Bred for 2011

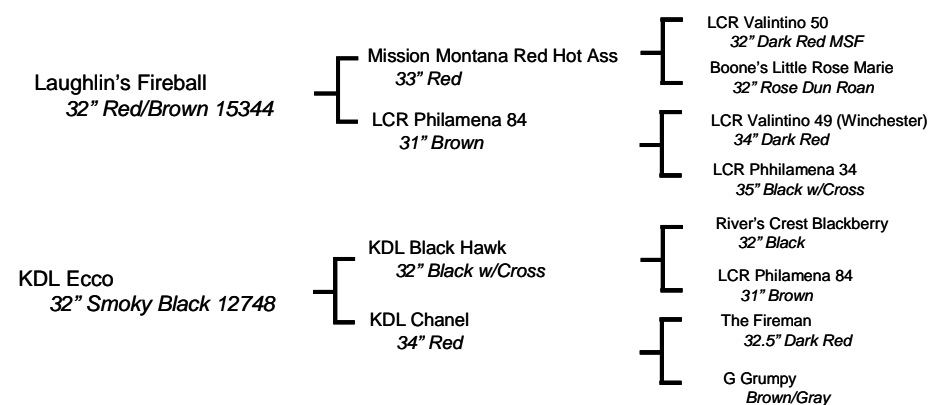

Pimento is a black cherry, very correct jennet, and is the mother of our Herd Sire, The Elms Pepperazzi, (black w/Cross NLP). She is a producer of quality foals, one a Herd Sire in Canada, one in Florida. Pedigree full of old bloodline greats, both jacks and jennets. Bred to black she has produced true black, bred to red gave red. Pimento is bred for 2011 to The Elms Red Hot Rudy (true black cherry red, DNA color typed, by Santana, out of MGF Red Hot Mama).