

2009 Sale Donkey List

Lot # Miniature Donkey

- 1 Sunset Acres Hope ^^^
- 2 Merry-Go-Round's Buttercup
- 3 Perfection's Tigress
- 4 Ass-pirin Acres 2 Hot 2 Touch
- 5 MGF Isadora 852
- 6 Hill Co Mini's Runaround Sue
- 7 Hill's Haven Nauni
- 8 Engman's Shawnee ***
- 9 West Prairie Jill
- 10 Arcadian Zarina
- 11 MGF Venus Aphrodite***
- 12 Perfection's Lovin' You
- 13 Donkarama's Strawberry Shortcake***
- 14 Continental Ashley
- 15 Bainbridge's Emerald Isle
- 16 Rearview's Pink Chablis ^^^ ***
- 17 DBL V Hurricane's Calypso
- 18 Sylvandell's Leapin' Lizzie
- 19 MGF Primrose 611 ***
- 20 Assphalt Acres Ring A. Rosie ***
- 21 Big Woods Secret Passion ***
- 22 MGF Hello Dolly 832
- 23 Merry-Go-Round's Button ZZ
- 24 Ass-pirin Acres Donata
- 25 Long Run Stuart Little ++
- 26 Daddy's Duchess ***
- 27 B.J. Ona Alaska

Lot # Miniature Donkey

- 28 Perfection's Penny 4 Yr Thoughts
- 29 Jalan's Candi ***
- 30 Parkside Wildfire ^^^
- 31 Donkarama's Margarita
- 32 MGF Time to Shine 781
- 33 Ass-pirin Acres Fortune Cookie
- 34 Windcrest Kewpie Doll ***
- 35 West Prairie Annie
- 36 Hill's Haven Callie
- 37 Merry-Go-Round's Easter Lilly
- 38 MGF Sands of Time 883
- 39 Bainbridge's Mystic Crystal
- 40 Hill Co Mini's Spitfire
- 41 Perfection's Peppermint
- 42 LN Little Deena ^^^ ***
- 43 Continental Blossom
- 44 Arcadian Sally
- 45 LUA Maxx's Sweet Caroline ***
- 46 Merry-Go-Round's PizaZZ
- 47 DBL V Hurricane's Nerissa
- 48 Ass-pirin Acres Cheska
- 49 MGF A La Carte 822
- 50 Perfection's Daylinda
- 51 Ozark Lil Jill ^^^
- 52 B.J. Julie
- 53 Donkarama's Material Girl***
- 54 Sylvandell's Sapphire

^^^ Foal by side

*** Bred

++ Driving Donkey with Cart & Harness

See WWW.DONKEYS.NET for Pictures

2010 Great American Miniature Donkey Sale
Sale Day – Saturday, July 31, 2010

Now is the time to select those special donkeys you will want to represent your farm breeding program in the 2010 Sale. Sale planning begins in December, deadline in February. Contact us anytime to discuss potential entries and details.



Saturday August 1, 2009
Historic Lebanon, Ohio - Fairgrounds

Select Miniature Donkeys from Breeders
Across North America

*Quality Conformation, Diverse Pedigrees, All Colors,
 Jennets - Yearlings, 2 year olds, Mature, Bred and With Foal
 Also A Driving Gelding With Cart & Harness*

Visit WWW.DONKEYS.NET for
Web Catalog with pictures

Sale Sponsors
Elms Farm Miniature Donkeys
The Elms Farm
Martha & Dowell Howard
Mason, Ohio
donkeys@donkeys.net
513-398-3341

Welcome To
The Great American Miniature Donkey Sale
Historic Lebanon, Ohio
At the Warren County Fairgrounds

June, 2009

Dear Donkey Enthusiast,

We are pleased to invite you to 7th annual Great American Miniature Donkey Sale, a select sale featuring quality registered miniature donkeys. The Sale will take place on Saturday, August 1, 2009 at 12:30 PM, at the Warren County Fairgrounds, next to the Lebanon Raceway, in Building C, in Lebanon, Ohio. We hope you plan to attend.

The Sale will consist of 54 miniature donkey lots. These miniature donkeys have been selected from those offered for consideration. Top breeders are consigning their best, as these donkeys publicly represent their farm and breeding program. It would literally take you many days, and thousands of miles, to view an assortment of available, quality stock like you will see represented at the Sale.

The selected miniature donkeys represent diverse bloodlines, great conformation, and a variety of sizes, colors & ages to attract breeders, show people, and donkey & equine lovers everywhere. Full information on each, including pictures (as consignors make them available), may be found on our web page, www.donkeys.net.

There is something for everyone here, whether you are an experienced breeder, or just getting started. Jennets include; yearlings, coming 2 year olds, mature jennets, bred jennets, and jennets with foals on the side. A trained driving gelding with cart & harness is also being offered. Donkey tack and gifts will be available. Whether you are looking for a single jennet, a jennet with foal, brood jennets for your breeding program, or a loving pet, you are assured of finding only quality miniature donkeys at this sale.

This Donkey Sale is more than just an auction; it is an event, a 'happening'. Donkey enthusiasts everywhere look forward to events such as this and we expect a large turnout from across the Continent. It is an opportunity for folks, both those with years of experience, and those first exploring miniature donkeys, to get together, share experiences, learn from each other, have some fun, make new friends, renew old friendships, and, oh yes, see, bid on, and purchase some of the finest quality miniature donkeys in North America.

We hope you plan to attend this year's Great American Miniature Donkey Sale. We are confident you will enjoy it.

Thank You for Your Support - Martha & Dowell Howard

Absentee Bidding:

You must be registered prior to the Sale to phone bid or to bid through another person. Do this early. Please review registration details at www.donkeys.net or call 513-398-3341, 513-225-1771 or 513-919-5613.

Sale Day Telephones: 513-225-1771 and 513-919-5613.

The Great American Miniature Donkey Sale
Schedule of Events

FRIDAY JULY 31, 2009 SALE SET-UP DAY

Friday is primarily a set-up and check-in day for the Sale. All donkeys must be on site by 4:00 to allow for consignor and vet check-in. There will be limited viewing during the late afternoon. Events are planned as follows:

Viewing Begins	3:00
Consignor's Invitational Dinner	6:00
Measurement	7:00

SATURDAY AUGUST 1, 2009 SALE DAY

Saturday is the Sale Day. Viewing will begin at 8:00. Breakfast & lunch will be available for purchase. The Donkey Sale starts at 12:30 and checkout begins shortly after the last lot is sold. Donkey tack, gifts, useful items and curios will be available.

Viewing Starts	8:00
Sale Vendors	9:00
Consignor Meeting	10:45
Sale Starts	12:30
Payment, Vet Papers	Shortly after last lot is sold
All Donkeys Removed	before 8:00 PM

SALE LOCATION & DIRECTIONS

The Sale will be held at the Warren County Fairgrounds, Bldg C, adjacent to Lebanon Raceway, on Route 48, (660 N. Broadway, Lebanon, OH 45036), 0.7 miles north of the town center of Lebanon, OH. The Lebanon Raceway, a private company, will be in operation, so no parking on paved areas. Parking for the Sale will be marked.

From I-75, take exit #29 (Monroe, Lebanon, Rt. 63) east to Lebanon, 7 miles. Turn left on Broadway (Rt 48 North), go 0.7 miles to the Fairground.

From I-71, take exit #28 (Rt 48), turn North, go about 2 miles to Rt. 123, exit west toward Lebanon, go 1 mile, turn right on Broadway, go 0.7 miles to the Fairground.

Auctioneering & Clerking
Kevin Wendt, Auctioneer
23855 State Route 161
Irwin Ohio 43029
419-566-1599
www.thewendtgroup.com
kevin@thewendtgroup.com

The Great American Miniature Donkey Sale

TERMS AND CONDITIONS

Terms: Terms of the sale are cash, good check, or credit card (surcharge) with photo ID. All donkeys must be paid for immediately at sale end. No donkeys may be paid for before Sale end nor removed before paid for. All donkeys must be removed by 8 PM. (We can help if you want to attend / phone bid, but won't have a trailer.)

Bidding: All donkeys sell to the highest bidder. Any disputes or challenges will be settled by the auctioneer, and his decision will be final. The auctioneer may reject any or all bids. Bids are per lot. Jennets with foals on the side sell as one lot.

Risk: Owners assume all risk for their donkey up to the point of sale. Buyers assume all risk at the moment the auctioneer declares the donkey sold. Under Ohio Law, all persons attending the Sale do so at their own risk. The Management, their staff, auctioneers & their staff do not assume responsibility for, and disclaim any liability of any kind for; accidents, loss (also animals), and/or personal property damages.

Announcements: Sale day announcements from the auction block take precedence over the material in the catalog or on the web. Every effort has been made to ensure the accuracy of the catalog and web material. However, we assume no liability for errors or omissions from any source.

Contract: The management, auctioneers, and employees act as agents for the seller, but assume no liability for either the buyer or the seller. Any representations made by the sales management are made on behalf of the seller.

The above terms and conditions shall constitute a contract between the buyer and the seller of each animal sold. All guarantees are between buyer and seller.

Health: The EIA/Coggins test will be less than 3 months old. Current health papers for transportation will be good for 7 days past sale date. Proof of pregnancy from a veterinarian is required for bred jennets, otherwise sold as exposed. **Buyers are responsible to obtain the paperwork they need from the veterinarian after payment immediately following the Sale.**

Transport: We may be able to help you get your donkey(s) home. Please let us know if you may need this assistance.

Export: Export buyers will assume all related export costs such as veterinary work, quarantine, shipping, etc. For further clarification, contact us, we export frequently.

General: Please note that information in the catalog has been provided by the consignors. Height data may be birth, immature or adult registered heights and are included only as helpful data. All donkeys will be measured in public view on Friday at the time shown on the schedule. We encourage you to personally inspect the donkeys you are interested in and / or talk with or contact the consignors.

Absentee / Phone Bids

You must be registered prior to the Sale to phone bid or to bid through another person. Please review registration details at www.donkeys.net or call 513-398-3341.

Please Bring This Catalog – Supplies Are Limited

The Great American Miniature Donkey Sale

Camping & Lodging

Camping: Camping available at the Fairgrounds for \$20. Water & electric hook-ups, dump station, restrooms & **HOT** showers. 250 ft from the Sale. Pay Martha.

Motels & B&B

	Motel	Miles from Sale	Address	Phone	Web
Lebanon					
	The Golden Lamb	1	27 S Broadway	513-932-5065	goldenlamb.com
	Shaker Inn	2	600 Cincinnati Av.	513-932-7575	shakerinnmotel.com
	Hatfield Inn B&B	5	2563 Hatfield Rd	513-932-3193	bbonline.com/oh/hatfield/
Mason (I-71, Exit 25 - Rt 741)					
	Kirkwood Inn	9	4030 S US Rte 42	513-398-7277	kirkwoodinn.com
	Super 8 Motel	9	5589 Kings Mills Rd	513-398-8075	super8.com
	Hampton Inn	9	5323 Beach Blvd	513-459-8900	hamptoninn.com
	Comfort Suites	9	5457 Kings Center Dr.	513-336-9000	comfordsuites.com
	Baymont Inn	9	2793 WaterPark Dr.	513-459-1111	baymontinns.com
	Microtel Inn Suites	9	5324 Beach Blvd	513-754-1500	microtelinn.com
Mason (I-71, Exit 19 - Fields Ertel Rd)					
	Days Inn	15	9735 Mason Montgomery	513-398-3297	daysinn.com
	Red Roof Inn	15	9487 Bardes Rd	513-398-3633	redroof.com
	Hyatt Place	15	5070 Natorp Blvd.	513-754-0003	hyattplace.com
	La Quinta	15	9918 Escort Drive	513-459-1111	lq.com
	Marriott	15	9664 Mason Montgomery	513-459-9800	marriott.com
West Chester (I-75, Exit 19 - West Chester)					
	Marriott	17	6189 Mulhauser Rd	513-874-7335	www.marriott.com
West Chester (I-75, Exit 22 - Tylersville Rd)					
	Wingate Inn	14	7500 Tylers Place Blvd	513-777-1101	www.wingatehotels.com
Monroe (I-75, Exit 29 - Rt 63)					
	Howard Johnson	8	150 New Garver Rd	513-539-9221	www.hojo.com
	Comfort Inn	8	120 Senate Dr	513-539-2660	www.comfortinn.com
	Hampton Inn	8	40 New Garver Rd	513-539-4400	www.hamptoninn.com

Elms Farm Miniature Donkeys

We strive to produce quality miniature donkeys with excellent conformation, great dispositions and personalities

- * **Correct, drafty donkeys, emphasizing sorrels, blacks, darks & spots**
- * **Large sorrel herd, one of the most genetically diverse anywhere.**
- * **Herd Sires - 3 Sorrels, 3 Blacks, 2 Spots, 1 Woolly**
- * **Every foal carries sorrel or black genes or both.**
- * **Breed stock selected from herds across North America**
- * **Each mating planned to strengthen desirable characteristics.**
- * **Foundation Herd Planning – Export Expertise**
- * **'Shipping Around the Corner or Around the World' SM**

2009 Consignor List

Arcadian Exotics, Paul and Gertrude Suorsa, 133 Branchton Rd.
Slippery Rock, PA 16057, 724-794-3288, ggsuorsa@embarqmail.com
Lots 10 & 44

Assphalt Acres, Steve and Jill Crim, 3640 N 775E, Manilla, IN 46150,
765-544-2567, assphalacres@yahoo.com, www.assphalacres.com,
Lot 20

Ass-pirin Acres, Marshlyn and Michael Reed, 4241 VT Rt. 17W, Addison, VT
05491, 802-759-2665, minidonk@together.net, www.asspirinacres.com,
Lots 4, 24, 33 & 48

Bainbridge's Long Ears Acres, Sandy Bainbridge, 60 Harker Rd.
Chesterfield NJ 08515, 609-324-0903, sabains@aol.com,
www.bainbridgeslongearsacres.com, **Lots 15 & 39**

Big River Miniature Donkey Farm, Jeff and Brenda Runge, 2236 M-A-M
Trail, Monmouth IL 61462, 309-734-6728, bjrunge@maplecity.com,
www.bigriverdonkeys.com, **Lots 16 & 42**

Continental Farm, Wayne and Joan Schuetz, 804 SE 11th St., Washington,
IN 47501, 812-254-0811, c 812-486-6809, continentalfarm@yahoo.com,
www.continentaldonkeys.com, **Lots 14 & 43**

Daddy's Darlin' Donkeys, Marion and Jean Sohl, 10180 Faulkner Rd.,
Cleveland TX 77328, 281-592-7002, masohl@sbcglobal.net,
www.daddysdarlindonkeys.com, **Lot 26**

Donkarama Magickal Farm, Mary L Weisfeld, 25521 Old Saltworks Rd.,
Abingdon, VA 24201, 276-628-5017, c 276-973-5683,
maryweisfeld@yahoo.com, www.braysandneighs.com (soon) **Lots 13, 31 & 53**

Double V Farm, Julie Branden, 8605 Kemman Rd., Hebron, IL 60034
847-308-6224, doublevfarm@hughes.net, www.dblvfarm.com, **Lots 17, 30 & 47**

Elms Farm Miniature Donkeys, Martha and Dowell Howard, 5600 Bethany
Rd., Mason, OH 45040, 513-398-3341, 513-225-1771, 513-919-5613,
mhoward@eos.net, www.donkeys.net, **Lots 1, 11, 21, 29, 45 & 51**

Gold Mine Farm, Jerry and Barb Persinger, 235 Caravella Court,
Livingston, TX, 77351, 936-328-0474, jpersinger4@aol.com,
www.goldminefarm.com, **Lots 27 & 52**

2009 Consignor List

Half Ass Acres Miniature Donkeys, Joe and Dayle Haworth, 2359 Feed
Mill Rd., Chapel Hill, TN 37034, 931-364-3715, minidonks@united.net,
www.minidonks.com, **Lots 8 & 34**

Hill Country Miniatures, Ed and Angela Preston, 339 E. Town East Blvd.,
Sunnyvale, TX 75182, 972-226-6386, draughtonpreston@sbcglobal.net,
www.hillcountryminiatures.com, **Lots 6 & 40**

Hill's Haven, Bill and Sue Hill, 3305 203rd St., Fort Madison, IA 52627,
319-372-3539, hillshaven@q.com, www.hillshavendonkeys.com,
Lots 7 & 36

Long Run Farm, KC and Betty Stegemoller, 3500 Utica Rd., Lebanon, OH
45036, 513-932-1601, longrunminidonks@aol.com, **Lot 25**

Merry-Go-Round Mini's, Marlene Clark, 14500 Van Syckle Rd., Gregory,
MI 48137, grclark@hughes.net, www.merry-go-round-minis.com,
Lots 2, 23, 37 & 46

McRoberts Game Farm, Jerry and Barb McRoberts, PO Box 55, Gurley,
NE 69141, 308-884-2371, jbmrcrob@daltontel.net,
www.mcrobertsgamefarm.com, **Lots 5, 22, 32, 38 & 49**

Perfection Miniature Donkeys, Val, Deone, Dakota & Wacey
Townsend, RR1 Site 7, Comp 14, Sylvan Lake, AB T4S 1X6 Canada,
403-887-2285, cell 403-350-7959, lsangus@telusplanet.net,
Lots 3, 12, 28, 41 & 50

Sheloy Acres, Joy Foss, RR4 Site 1 Box 18, Olds, AB T4H 1T8 Canada
403-556-6551, joynia@xplornet.com, www.sheloyacres.com, **Lot 19**

Sylvandell Farms, David and Paulette Klein, 254 Sylvandell Rd.
Cynthiana, KY 41031, 859-235-8950, jdkleinky@earthlink.net,
www.sylvandellfarms.com, **Lots 18 & 54**

West Prairie Farm, Gene and Betty Willmann, 5455 West
Prairie Dr., Belleville, IL 62220-5001, 618-235-0221, 618-578-9676,
genewillmann@sbcglobal.net, www.westprairiefarm.com. **Lots 9 & 35**

1 Sunset Acres *Hope*

Dark Brown Jennet, 4/28/98, Reg. #30227

Consignor: Elms Farm Miniature Donkeys, 33.5", Bred for 2009

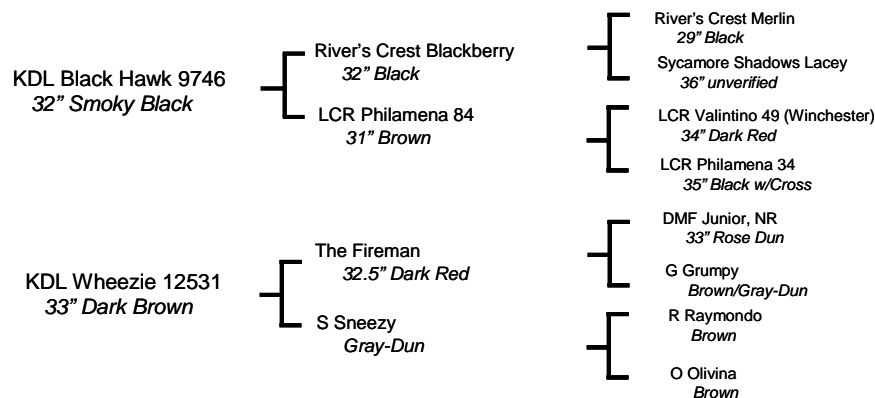

Hope is a quality brood jennet going back to foundation donkeys, including an import in the fourth generation. Her grand dam is the famous Philamena 84, a high selling brood jennet when in her teens. Hope's foals have been stocky, straight, robust, with perfect teeth, in a rich range of colors from black to red, also roans. Hope will have a foal at side by sale time, sired by our intense dark red 30" herd sire, The Elms Red Fusion.

2 Merry-Go-Round's *Buttercup*

Ivory BEW Jennet, 7/25/07, Reg. #51579

Consignor: Merry-Go-Round Mini's, 32" Feb 09

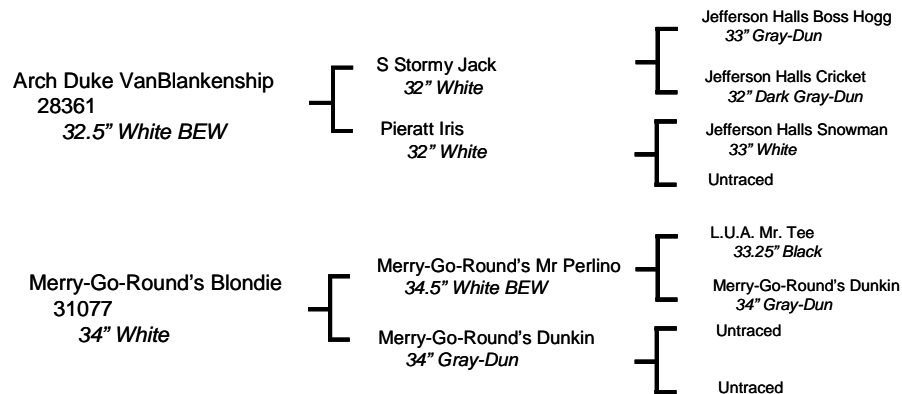

Buttercup is one of my beloved ivory, blue eyed white (BEW), donkeys that I decided to offer for sale. She goes back to Mr Perlino and also has Jefferson Halls and Pieratt in her pedigree. She is a nice creamy ivory with cross and stripe. Good conformation and build. Here is a rare opportunity to add an ivory donkey with a great pedigree to your herd.

3 Perfection's *Tigress*

Black Jennet, 7/21/08, Reg. #Pending

Consignor: Perfection Miniature Donkeys, 19" at Birth

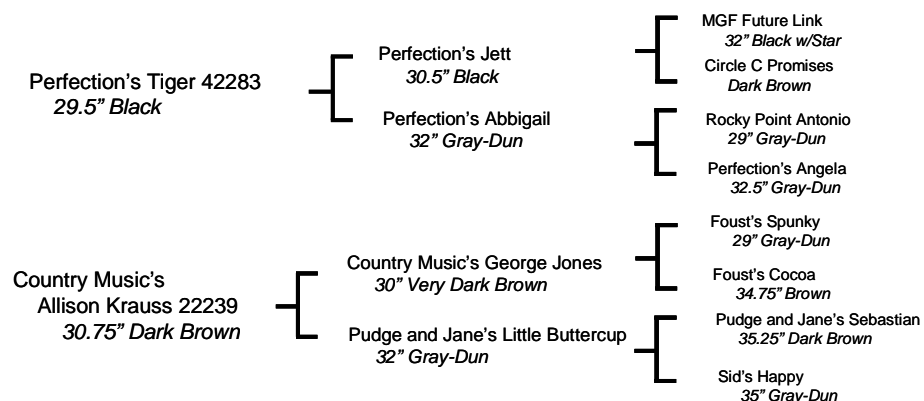

There's a Tiger in the house! Super Star bred to Super Stud has created a Tigress! Star Studded quality, with presence and attitude to burn, this little jennet is one to follow in the footsteps of her many time national champion mother and sisters. See if you can catch this Tiger by the tail!

4 Ass-Pirin Acres *2 Hot 2 Touch*

Red Jennet, 6/25/07, Reg. #52447

Consignor: Ass-Pirin Acres, 33" Mar 09

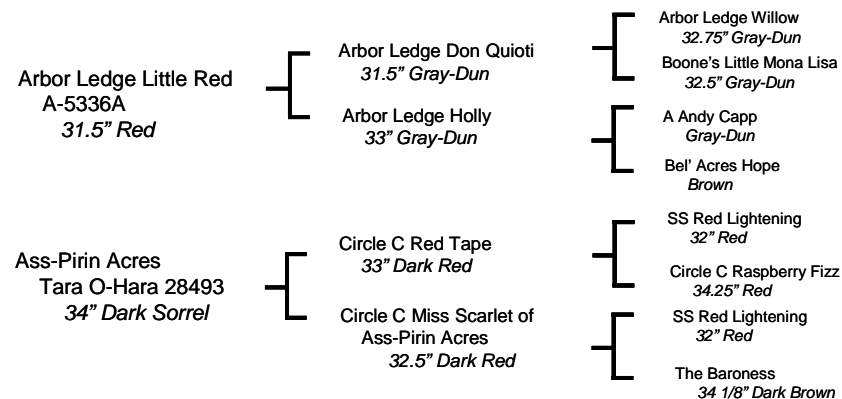

She was planned to be a great little sorrel. Her Grand Dam is the famous Circle C Miss Scarlet, World Champion Jennet and her Sire held top honors as well. Take a look at this two year old, and I bet you will like her. She has that look at me personality, yet a love bug as well.

5 **MGF Isadora 852**

Red and White Spotted Woolly FSW Jennet, 8/6/08, Reg. #Pending
Consignor: McRoberts Game Farm, 29.5" Mar 09

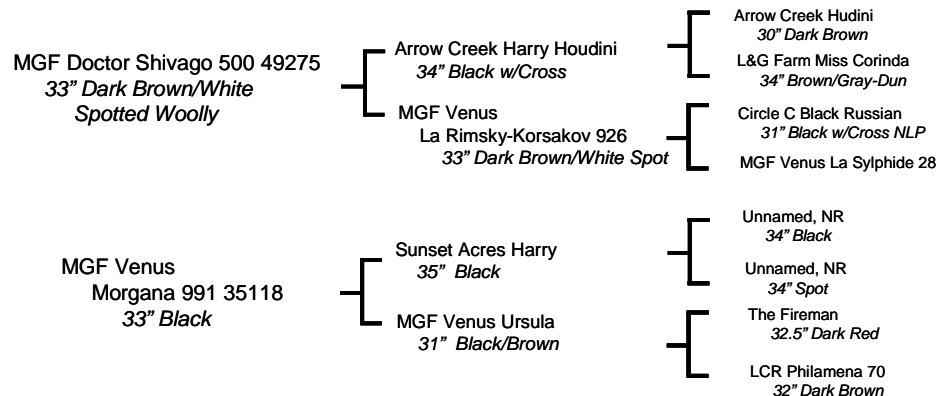

Morgana and Shivago hit a home run with this unbelievable jennet. This beautiful woolly sorrel spot is extremely well built....fairly small...and looks like a frosted sorrel at this writing. Isadora is as unique as anything we've ever produced.

6 **Hill Co Mini's Runaround Sue**

Black NLP Jennet, 9/6/08, Reg. #55141
Consignor: Hill Country Miniatures, 22" at Birth

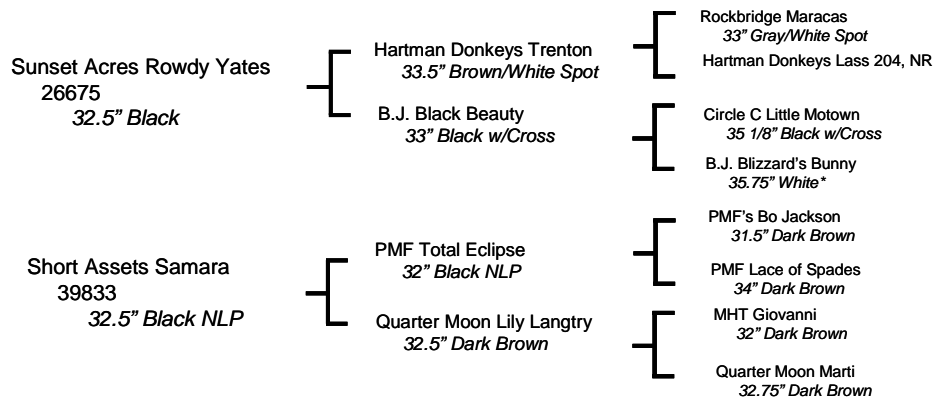

Runaround Sue has great conformation and a wonderful pedigree! She's a very stocky jennet, has a round butt, a level top line, great bone & chest, an excellent flowing movement, and that ink black color. Her full pedigree includes a number of well known donkeys & lines. She is show quality and show trained, is very willing and eager to please and has several siblings that have done very well in the show ring.

7 **Hauenstein's Amour**

Gray & White Spotted Jennet, 12/23/00, Reg. #29004
Consignor: Hill's Haven, 30.25", Bred for Fall 2009

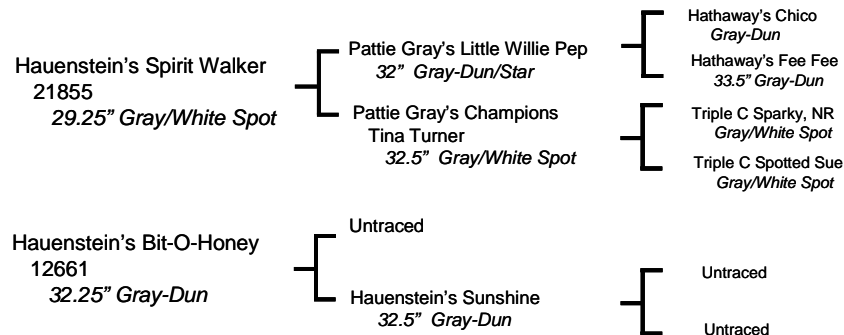

Amour's a nice small (30.25") proven spot. She's bred to The Elms Eric the Red, a dark red 30.75" jack, for a foal in late August to early September this year. There's a 50% chance the foal will be spotted. Amour foals easily and this will be her 5th. She has a great disposition and is easy to work with. Her pedigree is one which you spot breeders should like and includes the small Spirit Walker. Not long to wait before you will have a little one prancing in your field.

8 **LN Josica**

Black w/Cross Jennet, 7/2/97, Reg. #28560
Consignor: Half Ass Acres, 33", Bred for Nov. 2009

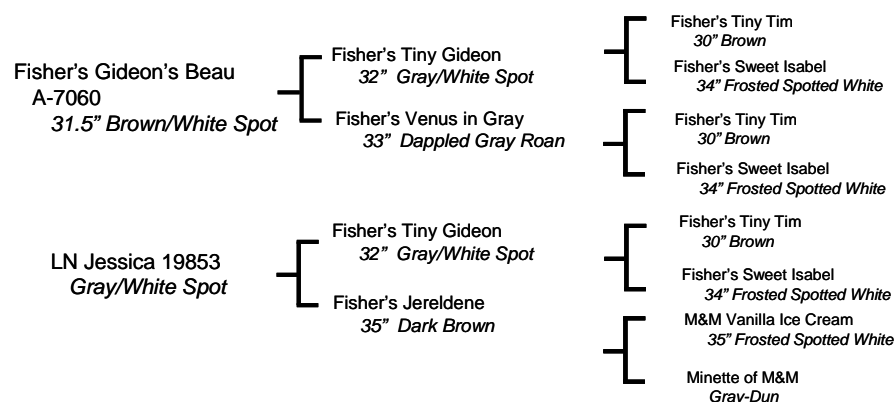

Josica was vet checked by ultrasound approximately 8 months safe in foal. She is bred to Wee Friend's Farm Blackberry, a 31" black w/cross jack with a super wide chest and very heavy boned. Donkeys just don't come any sweeter than Josica. She is easy to halter and a joy to handle. She has a nice round rear, straight legs, wide chest and a perfect bite.

9 West Prairie Jill

Brown Jennet, 10/19/07, Reg. #56440

Consignor: West Prairie Farm, 31" Mar 09

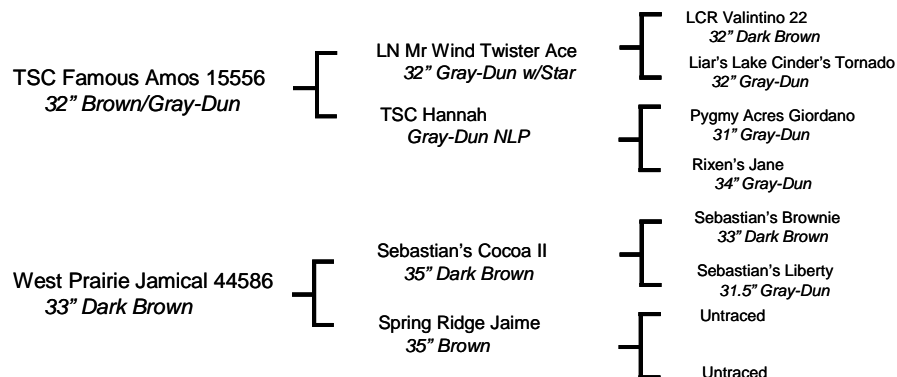

Jill has all the great features, a beautiful head, neck, shoulders, legs, feet. Her sire has a long line of great genetics. She will be a great little jenny to most herds. Her dam had four jenny foals in a row. Take a good look at this jenny.

10 Arcadian Zarina

Black w/Cross NLP Jennet, 6/21/08, Reg. #Pending

Consignor: Arcadian Exotics, 32" Mar 09

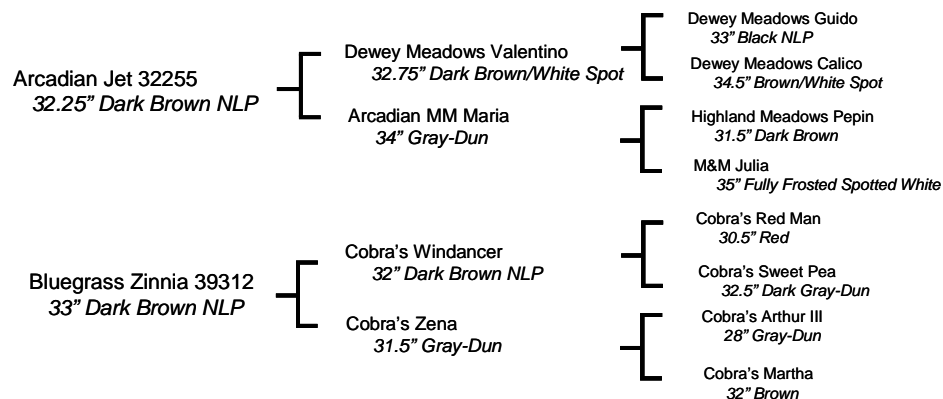

Zarina has a beautiful head, correct legs, and great motion with that look at me attitude. She has a great mix of some of the well known donkeys of the Dewey Meadows and Cobra lines. This Black, no light points (NLP), jennet would be ideal to cross with your special jack to bring these lines into your herd.

11 MGF Venus Aphrodite

Dark Red Jennet, 8/8/00, 32.5", Reg. #30468, Bred for 2010

Consignor: Elms Farm Miniature Donkeys

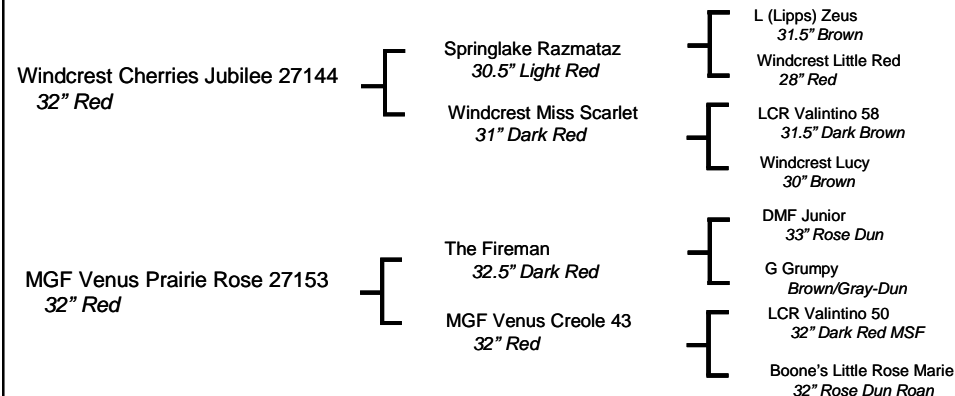

Aphrodite is an exceptionally beautiful dark red jennet, and mother of high quality foals. She is the dam of our herd sire, The Elms Red Fusion (30" intense dark red), and related to our other red jack, King of Hearts. She belongs in a red breeding program, so we regretfully offer her for sale. She has been bred to Santana for a 2010 foal that will be a full sibling to Red Fusion.

12 Perfection's Lovin' You

Dark Brown Jennet, 6/10/07, Reg. #53631

Consignor: Perfection Miniature Donkeys, 20" at Birth

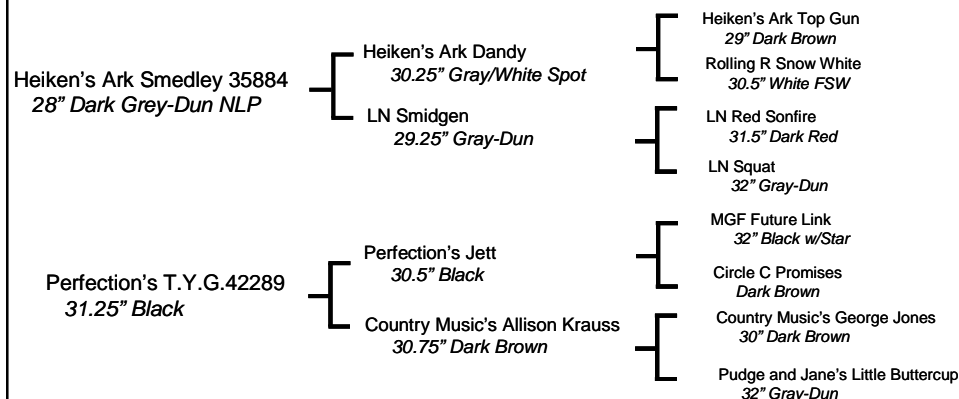

A granddaughter of the legendary World Champion and NMDA Champion Jennet Allison Krauss, Lovin' You's dam is the one everyone wants. NOT for sale! Smedley, our 28" grulla, was selectively crossed with some of our powerhouse jennets to produce the next full pedigreed line of ultra small donkeys. Here's a limited edition as we only had 4 foals by Smedley. Don't miss out on what is the next sure thing... LOVIN' YOU

13 Donkarama's *Strawberry Shortcake*

Red and White Spotted Jennet, 7/7/04, Reg. #Pending
 Consignor: Donkarama Magickal Farm, 32", Bred for 2010

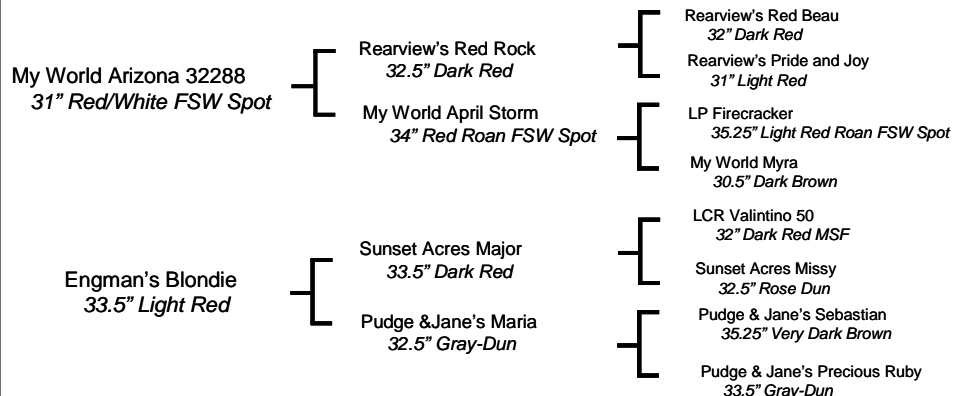

This dainty, mature jennet will add something special to your breeding program. She's a red and white sorrel frosted spot with strong genetics and a unique & wonderful style. For someone interested in the spotting factors and sorrel genes, she's the one for you. She has lovely manners and is easy to handle. She is bred to Engman's Pirate, a black/brown jack with Motown & Red Lightening genetics.

14 Continental *Ashley*

Dark Red Jennet, 4/19/07, Reg. #56299
 Consignor: Continental Farm

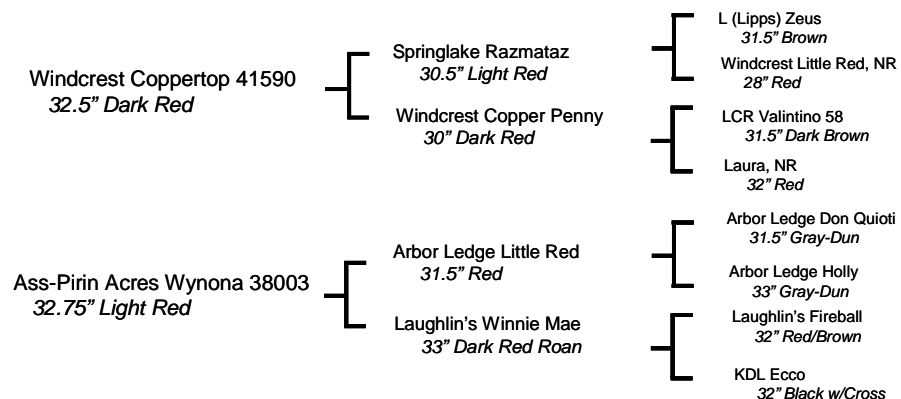

How sweet she is! Ashley has the look of sifted powdered sugar over her beautiful sorrel body. Her dark red color with strong white contrast will make her a show ring delight. Her sire is bright red, stocky, with a full rounded rump and lots of personality. You will appreciate Ashley's great conformation from near or far. She will surely add color to your herd when you purchase this sweet treat.

15 Bainbridge's *Emerald Isle*

Black and White Woolly Spotted Jennet, 8/11/08, Reg. #Pending
 Consignor: Bainbridge's Long Ears Acres, 27.75" Mar 09

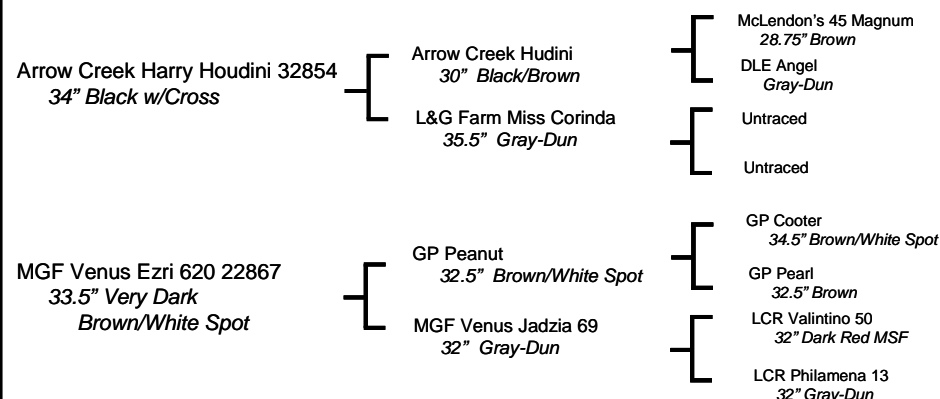

Fancy. Fancy. Fancy. This little girl is the whole package, great conformation, black and white. Long silky hair, and a great pedigree. Breeders would have to search the world over for a donkey such as this, but she is available in Ohio!

16 Rearview's *Pink Chablis*

Light Red Jennet, 9/9/04, 33.5", Reg. #40653, Bred for 2010

Big River Red Titan 09

Red w/Star Jack Foal, 5/12/09, 21.75" at Birth, Reg. # Pending
 Consignor: Big River Miniature Donkey Farm

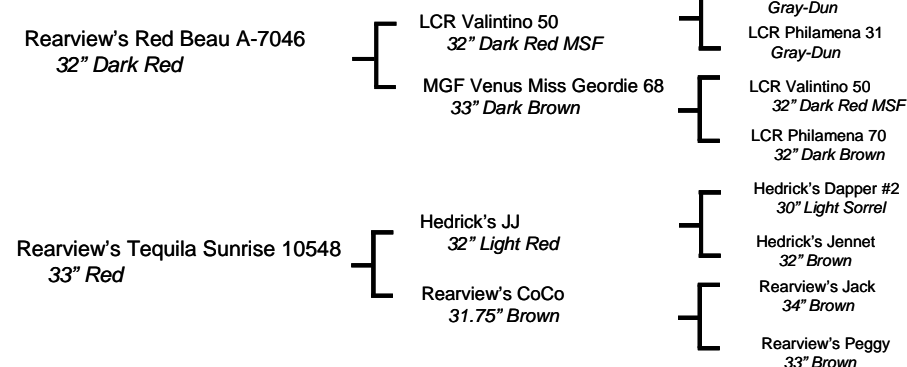

Pink Chablis is an eye catching sorrel jennet with a dynamic pedigree, with many top quality donkeys by long time breeders. Pink Chablis is offered with her 2009 foal, sired by D&F Farms Moon Beam (31.5" dark red by Happytime Acres Firecracker Red). She has been pasture exposed back to Moon Beam for a 2010 foal. This 3 in 1 family will set a solid foundation for your program.

17 DBL V *Hurricane's Calypso*

Light Red Jennet, 10/13/07, Reg. #51307

Consignor: Double V Farm, 30.75" Mar 09

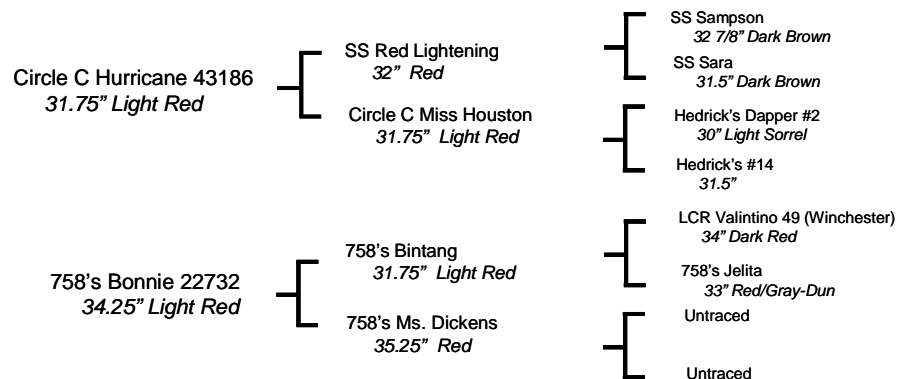

Calypso is named for the mythical sea nymph that bewitched Ulysses. This 2 year old Red Lightning granddaughter combined with 758's red lines offers a red package that is hard to beat. Let Calypso capture your heart and hold it hostage.

18 Sylvandell's *Leapin' Lizzie*

Gray & White Spotted Jennet, 2/29/08, Reg. #54560

Consignor: Sylvandell Farms, 31.75" Mar 09

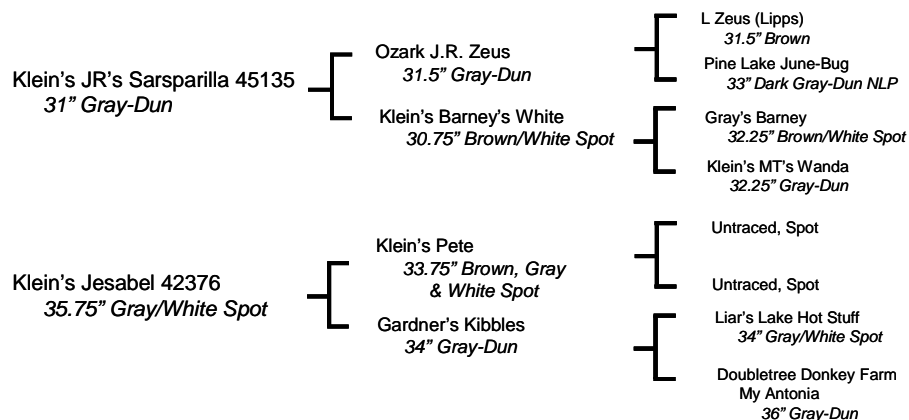

Leapin' Lizzie is a leap year baby- - she's stylish, correct, and very petite. She tugs on your pants leg if you don't acknowledge her and adores being scratched. She'll be a real asset to any breeding or show program.

19 MGF *Primrose 611*

Very Dark Brown Jennet, 8/10/06, Reg. #49272

Consignor: Sheloy Acres, 31 1/8" May 09, Bred for 2010

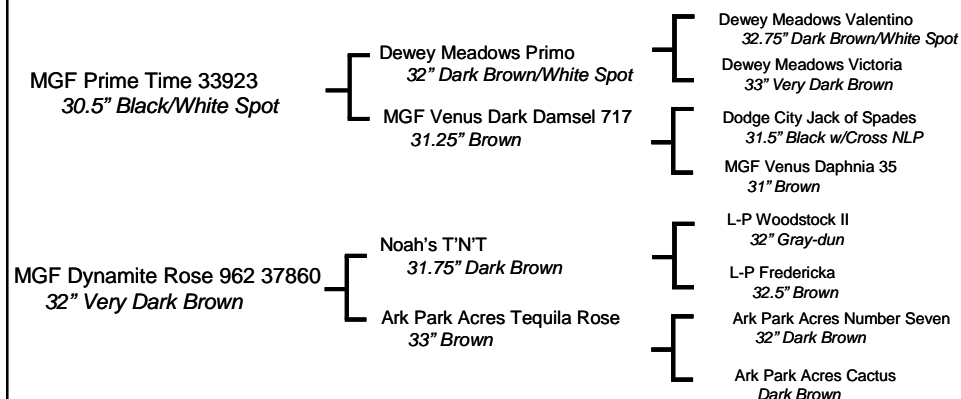

I am proud to offer one of my best, MGF Primrose, a fancy dark brown jenny bred to our own Sheloy's Calypso, AKA "Crusher" (MGF Future Link x Dark Gypsy of Circle C) to properly represent our farm. Crusher is a 30.5" super stocky true black NLP. The offspring from this combination should be phenomenal! MGF Primrose will add depth and quality to your herd. Don't let this one pass you by!

20 Assphalt Acres *Ring Around the Rosie*

Dark Red with Star Jennet, 6/17/03, Reg. #38544

Consignor: Assphalt Acres, 32.25", Bred for 2010

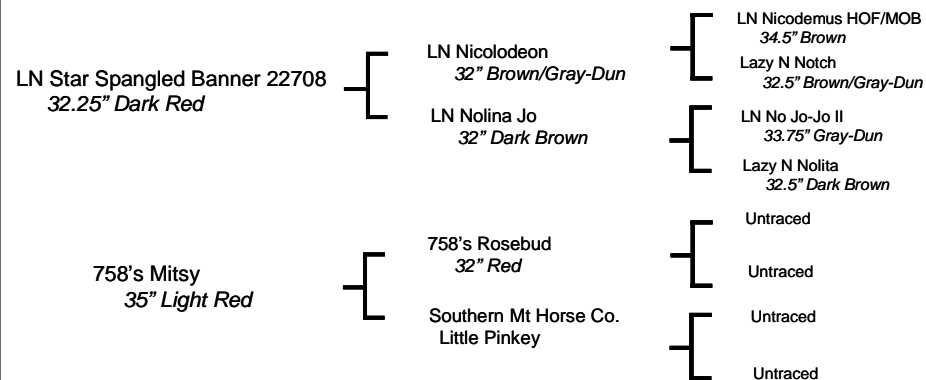

Rosie is a very nice petite jennet at 32". She has excellent conformation and disposition, and passes both on to her foals. She has thrown both red and black foals. If you like red with a pretty head, then this is the jennet for you. A great addition to any farm. Rosie is bred to Lawzyday Farm Cherokee, our 29.5" red jack for an April 2010 foal.

21 *Big Woods Secret Passion*

Black w/Cross NLP Jennet, 6/1/03, Reg. #37491

Consignor: Elms Farm Miniature Donkeys, 33.25", Bred for 2010

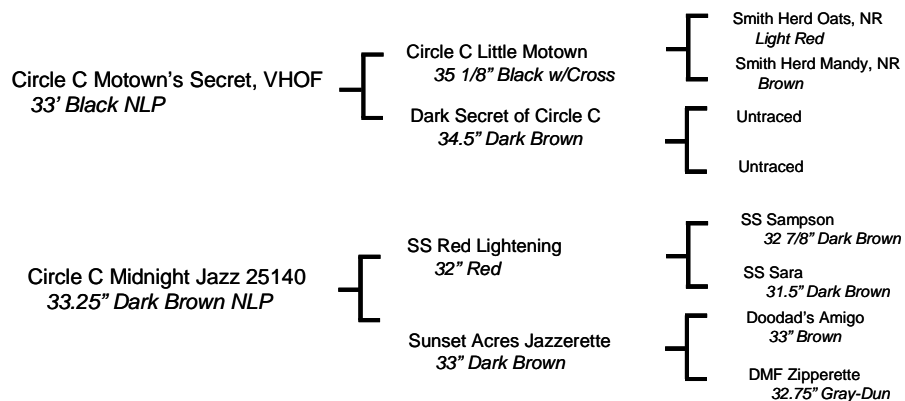

This splendid black jennet is a daughter of the Versatility Hall of Fame (VHOF) jack, Motown's Secret, and goes back to Red Lightening on her dam's side. Secret Passion gave us an awesome black jennet. She is bred to our very stocky, spotted woolly jack, Musketeer, for 2010, hoping for a richly spotted foal.

22 *MGF Hello Dolly 832*

Dark Brown & White Spotted Woolly Jennet, 4/30/08, Reg. #Pending

Consignor: McRoberts Game Farm, 28" Mar 09

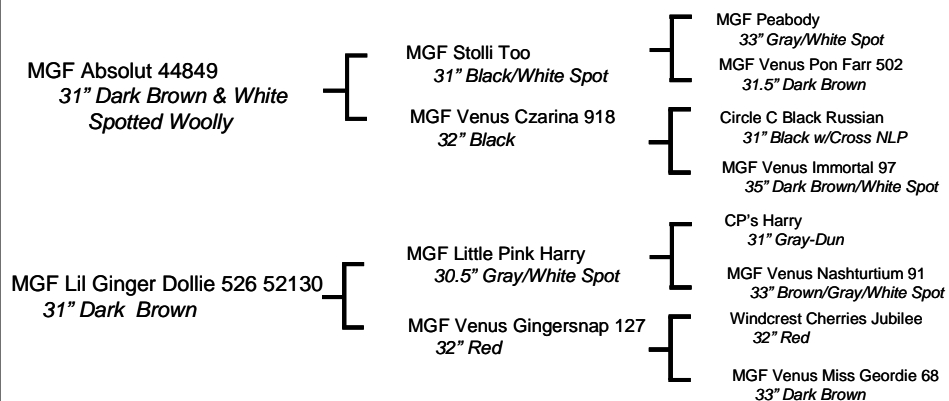

Hello Dolly - - our prettiest Absolut daughter of the year. She will probably mature under 31". Super woolly... has great color... and is just a knockout!!

23 *Merry-Go-Round's Button ZZ*

Very Dark Brown Jennet, 8/24/07, Reg. #51576

Consignor: Merry-Go-Round Mini's, 29" Feb 09

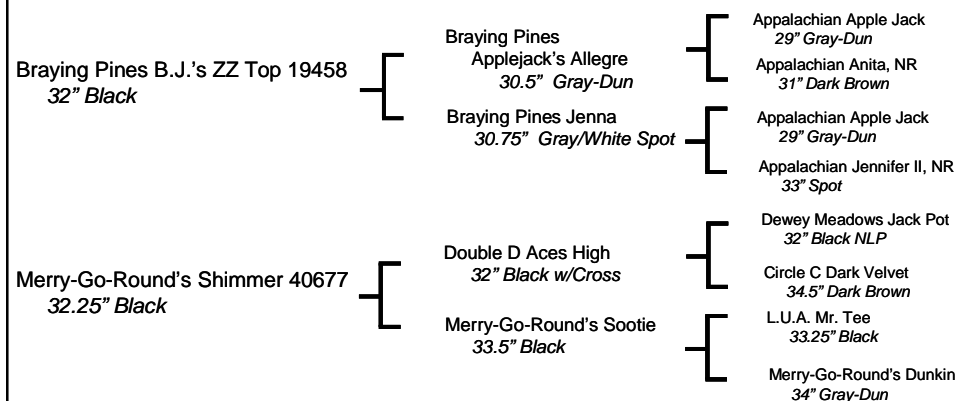

Button ZZ is a very dark, well put together jennet. She has no visible cross or stripe. Her dam, Shimmer, consistently gives me small foals, that remain small. Here is a nice jennet with good black genetics to add to your herd.

24 *Ass-Pirin Acres Donata*

Gray and White Spotted Jennet, 5/9/07, Reg. #52441

Consignor: Ass-Pirin Acres, 34" Mar 09

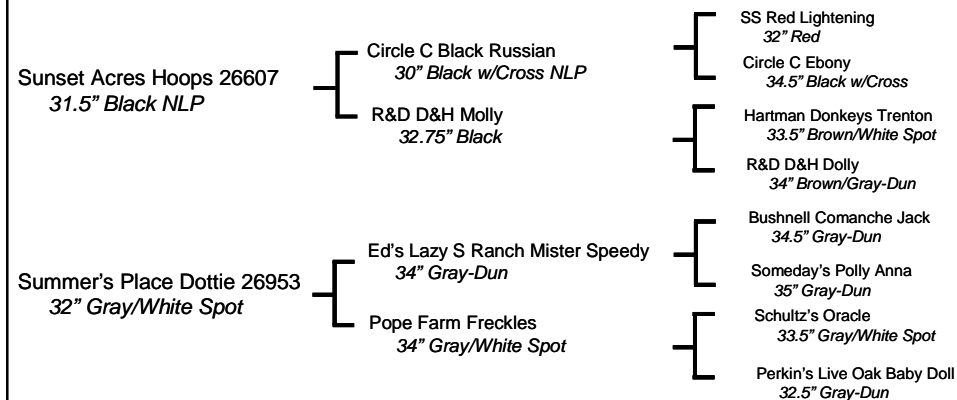

Gorgeous spot girl, with not only the pizzazz, but has conformation and pedigree as well. Put this one in the show ring and pin some ribbons on your wall now, then spiff up your breeding pen later. She is a two year old, you do not have long to wait. If spots are your game, Donata's her name.

25 Long Run *Stuart Little*

Gray and White Spotted Gelding, Harness Trained

Consignor: Long Run Farm, 5/9/06, 35" Mar 09, #46602

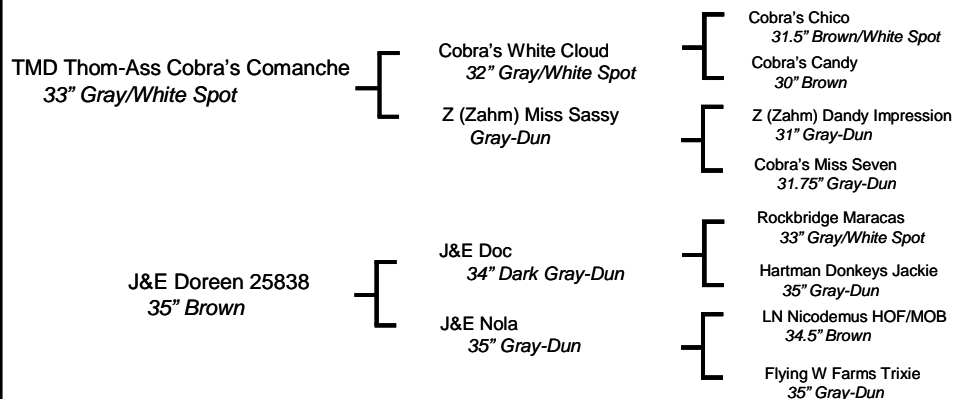

Stuart is ideal for a driving donkey, with the size and build to never let you down. Great disposition and first to come up to you in the pasture. A 4-H donkey in 08, he has done petting zoos & nativity scenes since a foal & demonstrated log skidding & coon jumping at Equine Affaire. He stands quietly for trimming / clipping. He will be a superb PR donkey for your farm & well broke to cart at sale time. Sells with cart and harness!

26 Daddy's *Duchess*

Brown Roan Jennet, 4/11/01, Reg. #31110

Consignor: Daddy's Darlin' Donkeys, 33.5", Bred for 2010

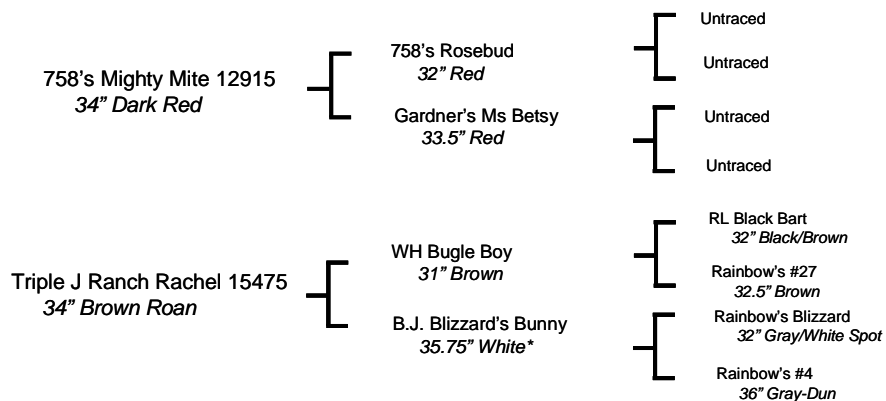

Duchess has a nice round hip, wide chest, and good balance. She has produced black and carries the dark nose recessive gene. Her sire is red, so if bred to a red, each foal has a 50% chance of being red. She's pasture bred to Ass-Pirin Acres Jes N'Credible, (31.25" - Ass-Pirin Acres LN Rising Son X Ass-Pirin Acres Jesta Starfire) for a 2010 foal.

27 B. J. *Ona Alaska*

Gray and White Spotted Jennet, 8/1/08, Reg. #55679

Consignor: Gold Mine Farm, 20" at Birth

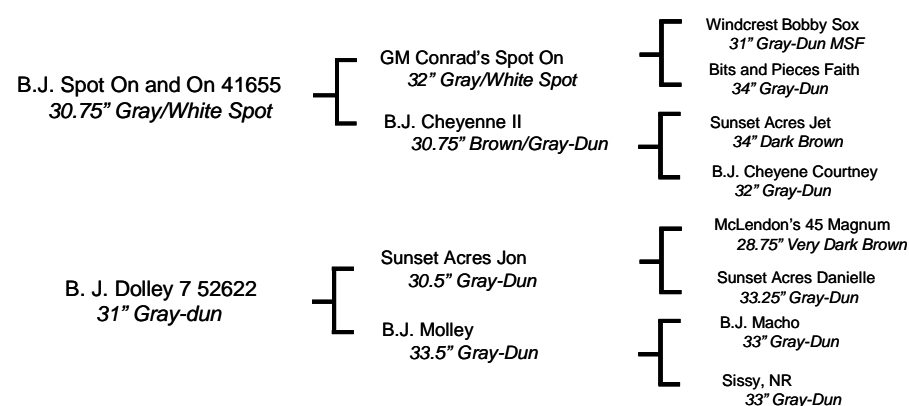

Here is a stocky little spotted jennet. Notice her legs and head. Her sire and dam are both small and she has some famous names behind her. Ona Alaska is friendly, and strives for attention. She should fit in any spotted program.

28 Perfection's *Penny 4 Your Thoughts*

Dark Brown Jennet, 9/27/07, Reg. #53628

Consignor: Perfection Miniature Donkeys

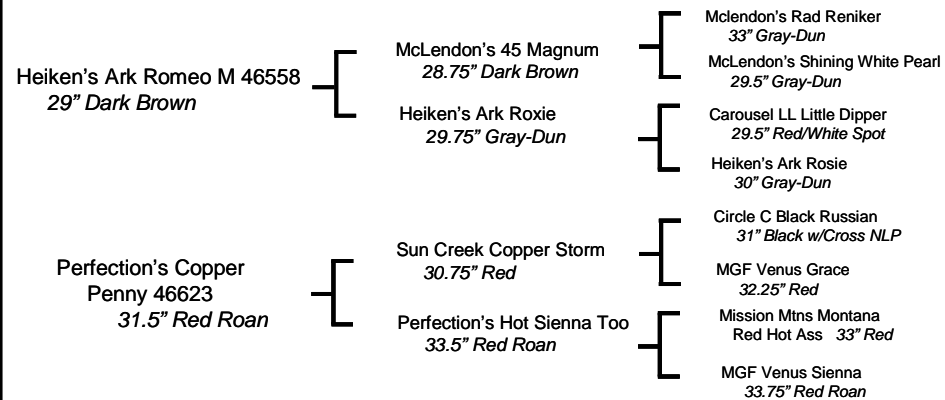

Our first Romeo daughter to sell and she is a little Penny. Penny 4 Your Thoughts has a strong full pedigree that combines most of the greats in the donkey industry today. Penny is a jennet that will compliment any ultra small or red breeding program. Penny 4 Your Thoughts....?

29 *Jalan's Candi*

Dark Brown Jennet, 7/30/01, Reg. #30577

Consignor: Elms Farm Miniature Donkeys, 33.25", Bred for 2010

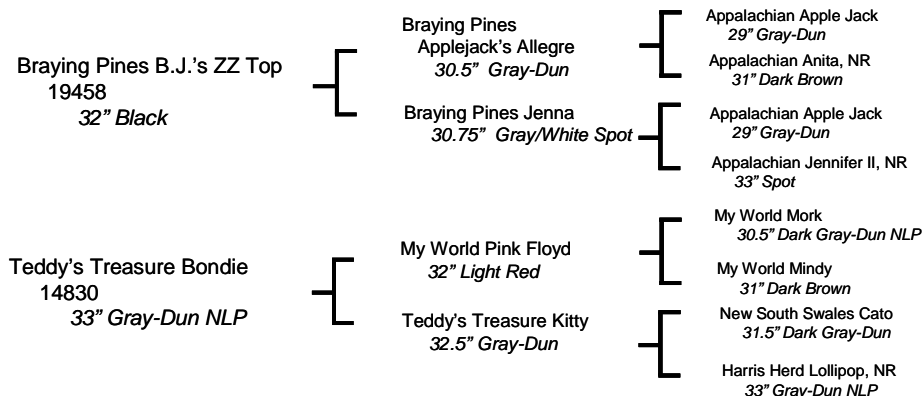

Candi has been a jennet producer for us, all stocky and straight. With a round hip, good back line, wide chest, and good bone, Candi is what most people look for in a brood jennet. She is bred to our small spotted herd sire, Geronimo, for a 2010 foal. Geronimo's first foals have been mostly jennets, and several fabulous spots.. Here is your chance to get a proven producer and a super Geronimo foal!

30 *Parkside Wildfire*

Light Red Jennet, 6/1/02, 32.75", Reg. #33796

DBL V Hurricane's Lightning

Light Red Jack Foal, 5/27/09, Reg. #Pending

Consignor: Double V Farm

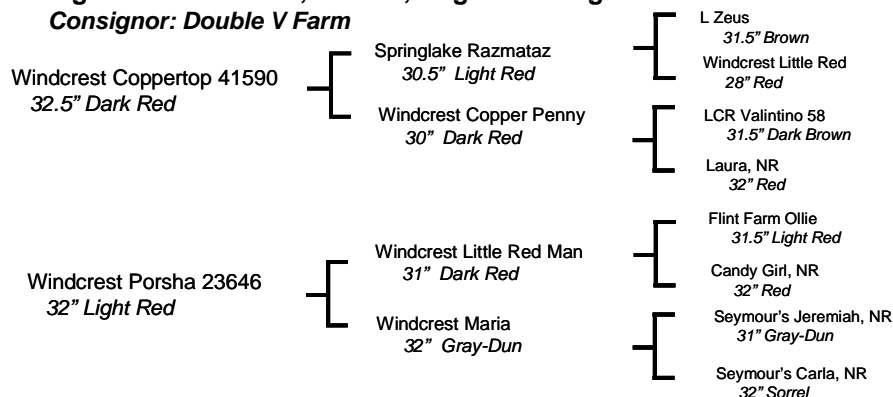

Well, you know what they say about redheads, they spark a fire in your heart! Wildfire...just imagine this ravishing red beauty grazing in your emerald green pasture. Plus, she has a jack foal at side, sired by Circle C Hurricane (31.75" Light Red). Lightning has a unique zigzag cross on one side. These two will blow you away!

31 *Donkarama Margarita*

Dark Red Jennet, 6/27/07, Reg. #Pending

Consignor: Donkarama Magical Farm, 30" Mar 09

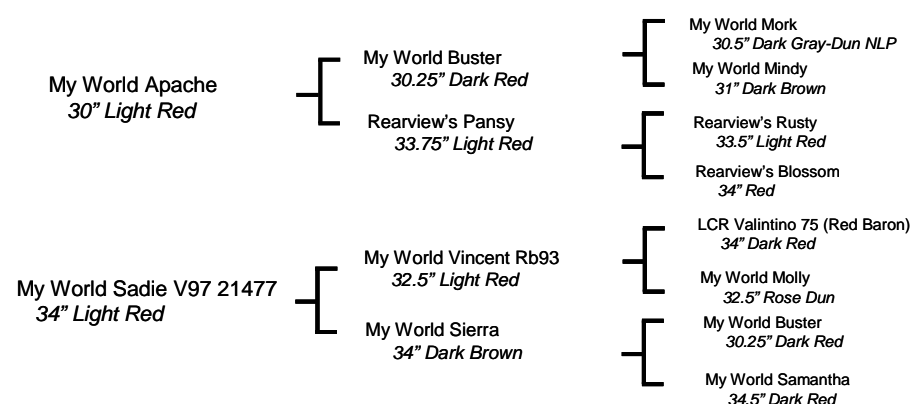

If you want to add sorrel genetics to your program, this little 2 year old jenny is one to consider. She's dainty, tiny, has nice limbs and a lovely little head. Her great genetics include a combination of MW Vincent and MW Buster. Don't miss your chance to take this darling home and allow her to mature for next year's breeding season.

32 *MGF Time to Shine 781*

Dark Brown & White Spotted Jennet, 7/28/07, Reg. #Pending

Consignor: McRoberts Game Farm, 31.5" Apr 09

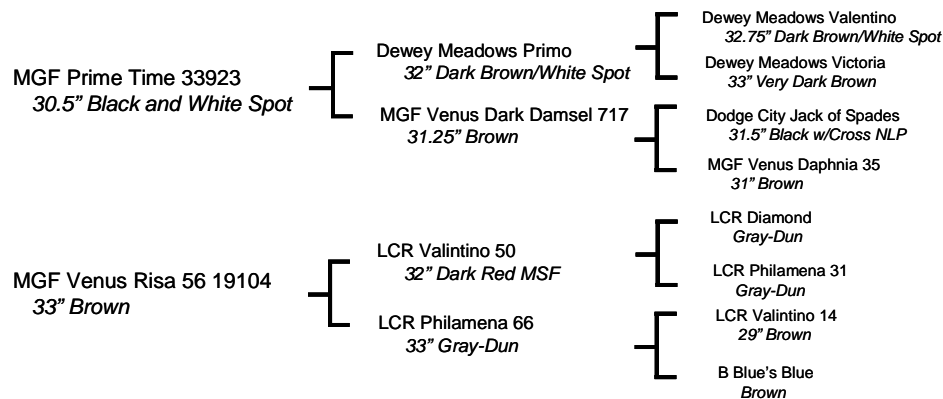

Time to Shine is an extremely attractive black and white spotted Prime Time daughter. She has beautiful color placement and will probably mature at less than 32 inches. Her pedigree includes some interesting donkeys. Her mother, Venus Risa, is one of our original Valentino 50th daughters. Time to Shine is very typy and well built.

33 Ass-Pirin Acres *Fortune Cookie*

Black with Star Jennet, 6/17/08, Reg. #55401

Consignor: Ass-Pirin Acres, 29" Mar 09

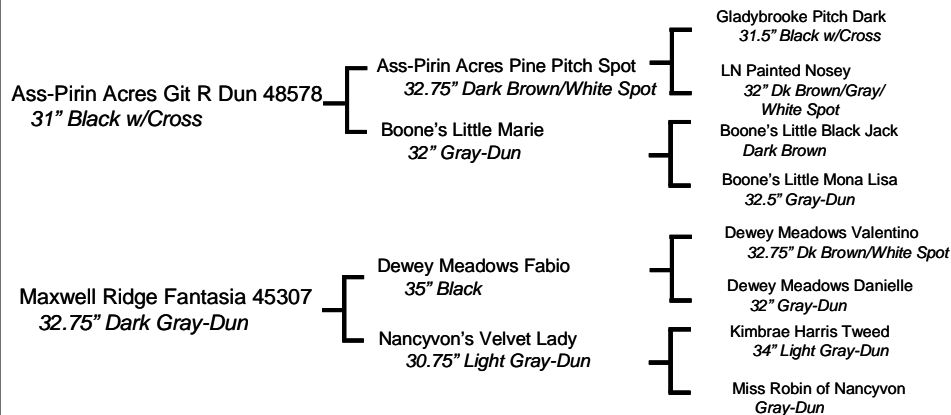

With her special little star on her forehead, and her black coat, she's a standout. She has the look of a winner and the sweetest personality. She is correct and balanced. What more can I say? She is a beauty!

34 Windcrest *Kewpie Doll*

Brown/Gray & White Spotted Jennet, 7/26/00, Reg. #27628, SA 1605

Consignor: Half Ass Acres Miniature Donkeys, 33", Bred for 2010

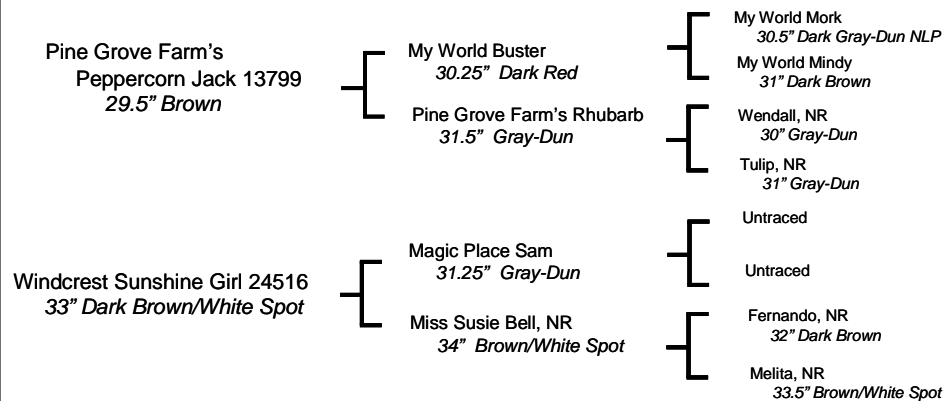

Kewpie is a wonderful spotted jennet with a beautiful head and nice round rear end. She has had 3 foals and she is a great mom. Easy to catch and handle. Up to date on all vaccinations including West Nile and microchipped. Bred to a tiny black jack, Wit's End Badlands Marauder.

35 West Prairie *Annie*

Brown Jennet, 11/11/07, Reg. #56439

Consignor: West Prairie Farm, 30" Mar 09



Annie's a small jennet with a full pedigree by Heiken's Ark Felix, a son of Top Gun (29"). Her dam goes back to the Hartman herd. She has great breeding in her pedigree. She will be small and will be almost 2 years old by Sale time. This will be a great jenny for most herds. Do not pass this great little jenny up, she has wonderful features.

36 Hill's Haven *Callie*

Light Red Jennet, 8/18/08, Reg. #55098

Consignor: Hill's Haven, 21.5" at Birth

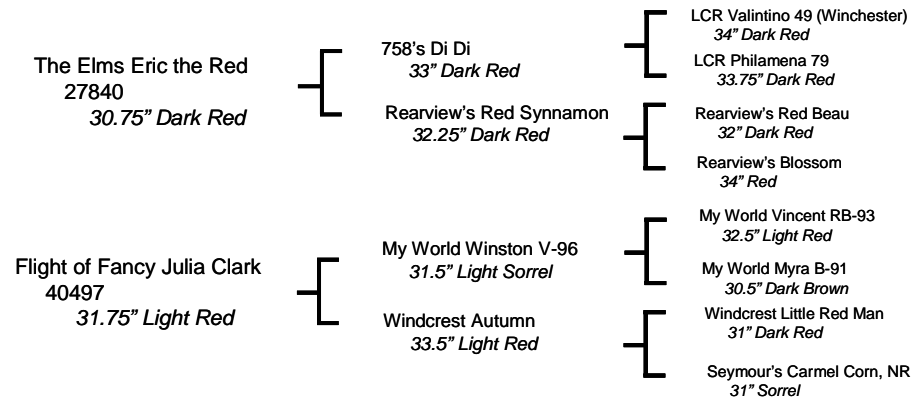

Hill's Haven Callie's pedigree is stacked with reds. She has a great breeding combination of Jane Savage's Flight of Fancy, combining genetics of Julia Clark, My World Winston, Windcrest Autumn, My World Vincent, & Windcrest Little Red Man with The Elms Eric the Red's line. The Elms Eric the Red's background is full of striking dark reds including the bright red, 758 Di Di, and many of Rearview Acres' beautiful reds. If you want red, this gal has it all.

37 Merry-Go-Round's *Easter Lily*

Gray-Dun Jennet, 4/8/07, Reg. #51574

Consignor: Merry-Go-Round Mini's, 32.5" Feb 09

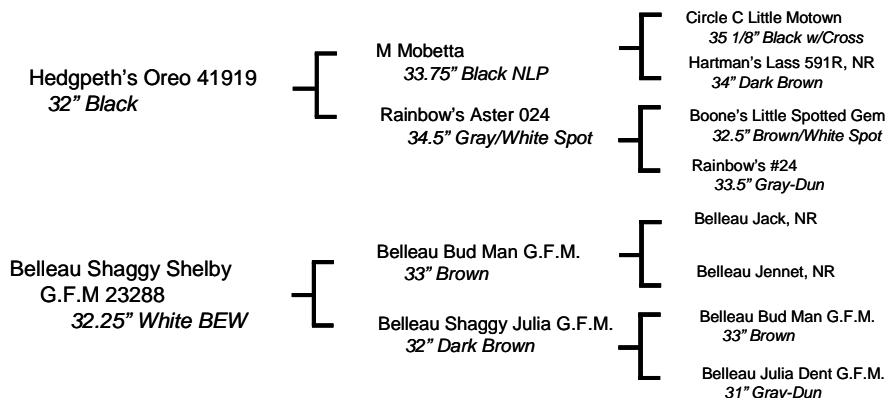

Easter Lily is a drafty jennet with leg garters and extensive stripe laddering. Her sire is a registered black, going back to Motown and Boone's breeding. Her dam is one of the draftiest Blue Eyed Whites (BEW) I have ever seen with a GFM Belleau pedigree. Lily is an ivory carrier, and bred to ivory, she can produce it. A great opportunity to add the BEW gene to your herd.

38 MGF *Sands of Time 883*

Dark Red Jennet, 7/1/07, Reg. #Pending

Consignor: McRoberts Game Farm, 29" Mar 09

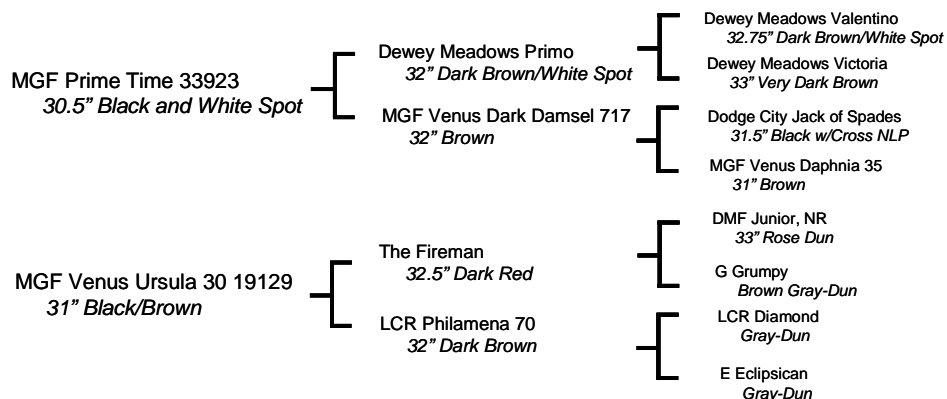

Prime Time hit a home run with this bright red gal, showing his recessive red combined with one of our top Fireman daughters — MGF Venus Ursula. She should stay under 31 inches... and is really well built.

39 Bainbridge's *Mystic Crystal*

Dark Brown & White Spotted Jennet, 4/18/08, Reg. #54680

Consignor: Bainbridge's Long Ears Acres, 29" Mar 09

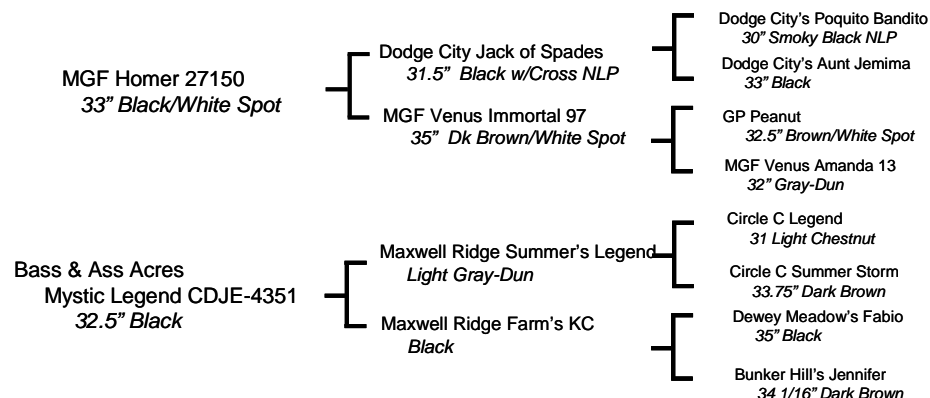

Crystal is a showy, well built jennet. The more she matures, the better she gets. She has good teeth, straight legs and a nice round butt. Any breeder or show farm would be proud to add this one to their herd.

40 Hill Co Mini's *Spitfire*

Dark Red Jennet, 10/26/08, Reg. #55142

Consignor: Hill Country Miniatures, 22" at Birth

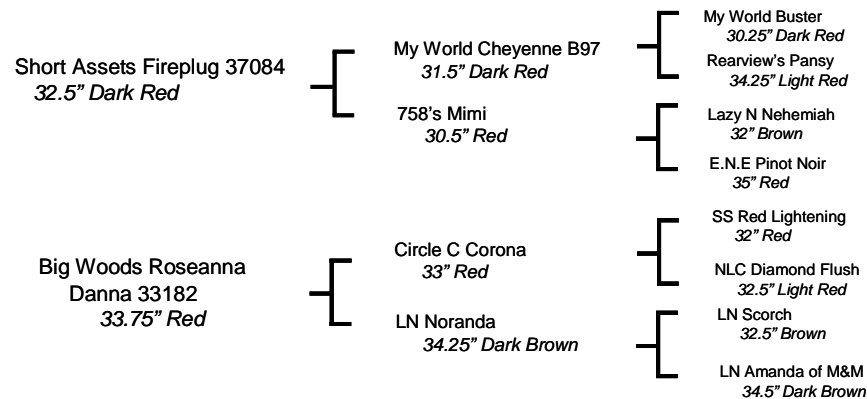

Dark sorrel show quality jennet. Her mother and father both have extensive show winning records, and they produced a winner here! Short, dished head, well balanced body, great top line, straight legs, and she moves like a dream! She will brighten up your pasture and light up the show ring!

41 Perfection's *Peppermint*

Dark Brown Jennet, 9/17/06, Reg. #50133

Consignor: Perfection Miniature Donkeys

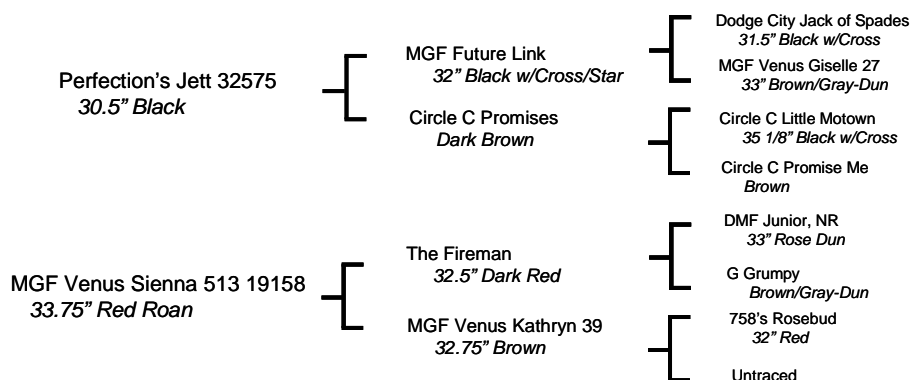

A blend of the finest and favorites here at Perfection Miniature Donkeys! A pedigree that will be very hard to offer again, as Jett is retired, so only a few daughters will be offered for sale. The icing on this sweet little PEPPERMINT is Sienna and the one and only 'Momma Donk', Kathryn. She still graces our pastures at 19 & we treasure her granddaughters. Don't miss getting a piece of the Kathryn Legacy.

42 LN *Little Deena*

Gray-Dun Jennet, 8/8/03, 34" Reg. #42012, Bred for 2010

Big River *All that JAZZ*

Dark Gray-Dun Jack Foal, 6/1/09, 21.5" at Birth, Reg. #Pending

Consignor: Big River Miniature Donkey Farm

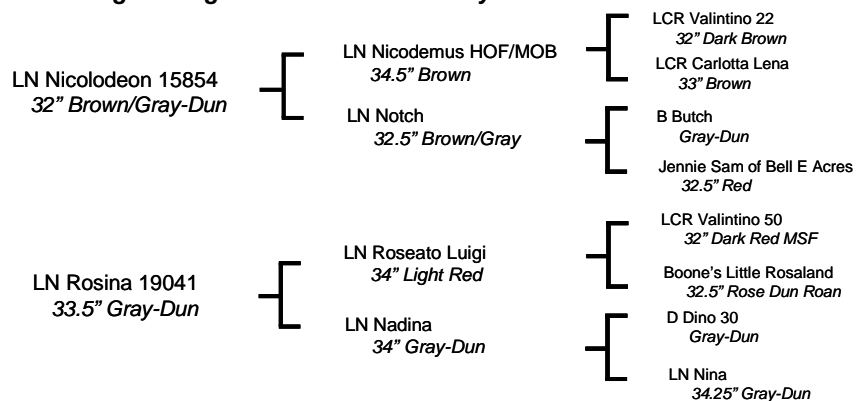

Little Deena is a stocky well proportioned jennet who has a full pedigree and is being offered with her 2009 foal, sired by D&F Farms Moon Beam (31.5" Dark Red). She has been bred back to Moon Beam, for a 2010 foal. This 3 in 1 family will set a solid foundation for your program.

43 Continental *Blossom*

Dark Red Jennet, 4/28/08, Reg. #56300

Consignor: Continental Farm

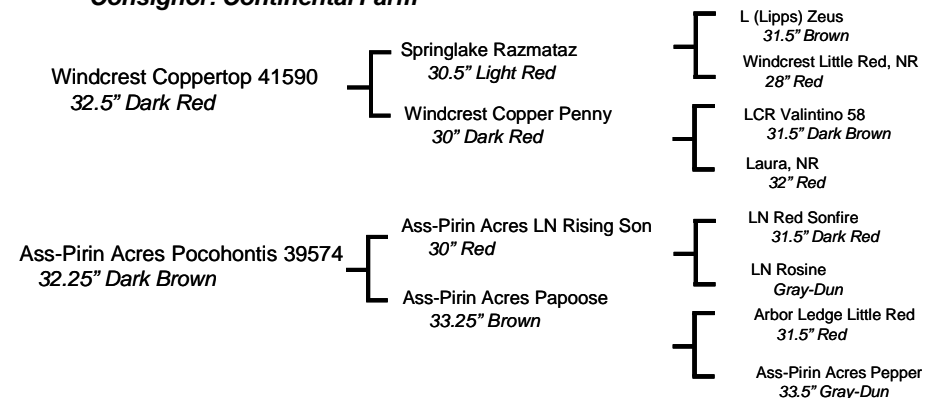

Blossom is another bloom from the bouquet of beautiful animals at Continental Farm. She's the second dark red sorrel from Pocohontis. Blossom has collected red genes from both sides, giving her a deep sorrel color. Her sire, Coppertop, is a stocky, full rounded rump jack whose name truly describes his color. Neither 1-800-Flowers nor FTD can deliver this Blossom, but you can take her home with you.

44 Arcadian *Sally*

Brown NLP Jennet, 10/11/07, Reg. #52526

Consignor: Arcadian Exotics, 31.25" Mar 09

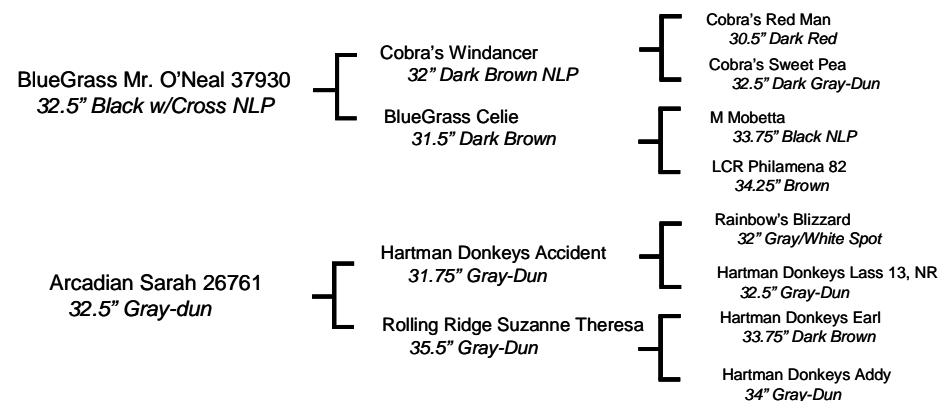

Arcadian Sally is lovely, with a beautiful head, outstanding neck, good legs and an even bite. Arcadian Sally traces to Rainbow's Blizzard and Hartman lines on her dam's side. Her sire, BlueGrass Mr O'Neal has Cobra breeding by Windancer, Redman, Arthur II and Arthur. Sally 's genetics should complement most serious breeding programs.

45 L.U.A. *Maxx's Sweet Caroline*

Black w/Cross Jennet, 8/16/99, Reg. #25336

Consignor: Elms Farm Miniature Donkeys, 32.75", Bred for 2010

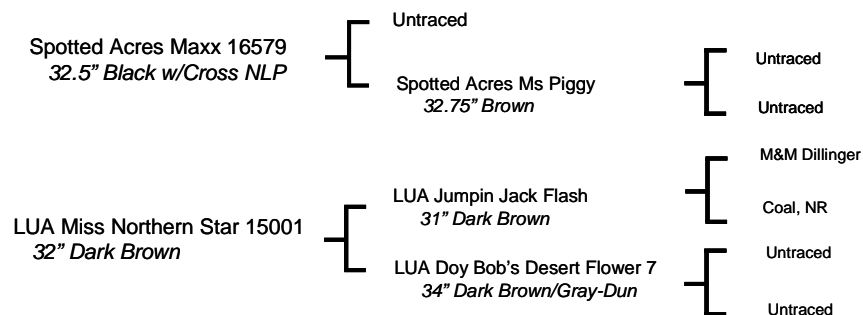

A proven true black producer, Caroline has had three jennets for us. Her foals have that glossy blue black color. All have had great chests, good bone on the legs, and perfect teeth. We retain two daughters in our breeding herd, The Elms Black Lace and The Elms Black Diamond. Caroline sells bred to our black herd sire, The Elms Rembrandt, for a 2010 foal.

46 Merry-Go-Round's *PizaZZ*

Black Jennet, 8/25/07, Reg. #51577

Consignor: Merry-Go-Round Mini's, 31.75" Feb 09

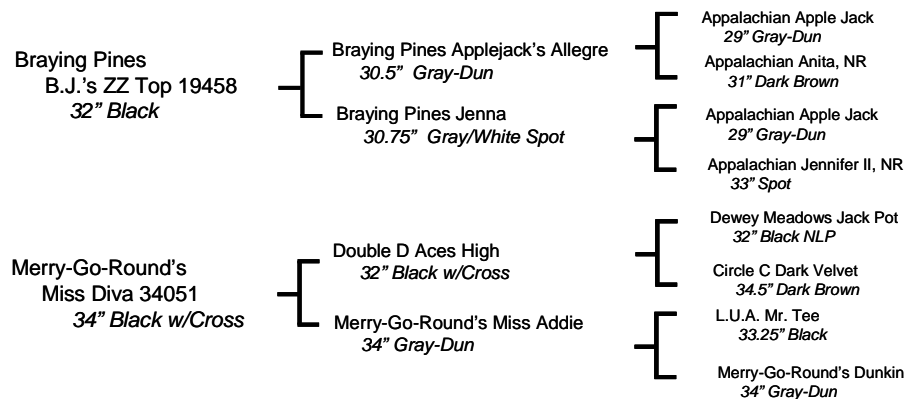

PizaZZ is a nice black jennet with multiple black genetic lines in her background. She has great conformation and rich deep color. No visible cross or stripe, and limited white points. Here is a dynamite girl to add to your herd if you are looking for black.

47 DBL V *Hurricane's Nerissa*

Light Brown Jennet, 8/22/06, Reg. #50548

Consignor: Double V Farm, 29.5" Mar 09

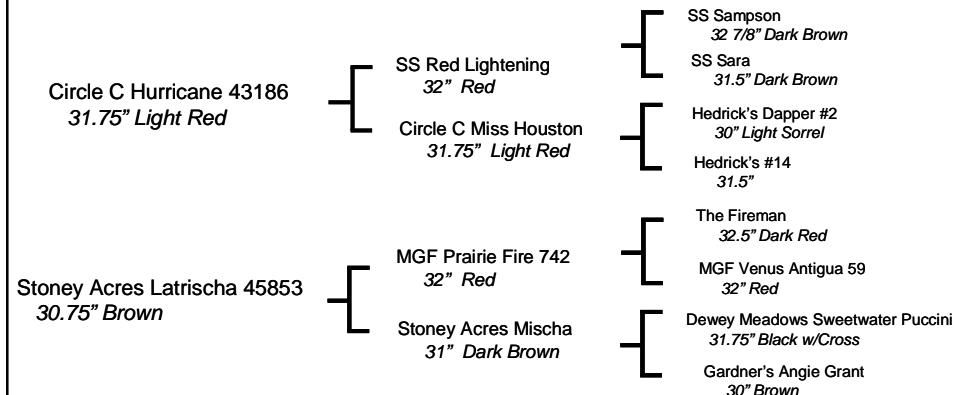

Ask me where fancy is bred and I tell you it's bred into Nerissa. Hurricane's charming daughter is tiny, but don't underestimate her. This premier three year old comes from generations of small. Plan to add her small genetics to put the style in your mini breeding program.

48 Ass-Pirin Acres *Cheska*

Black NLP Jennet, 5/20/08, Reg. #56398

Consignor: Ass-Pirin Acres, 28.5" Mar 09

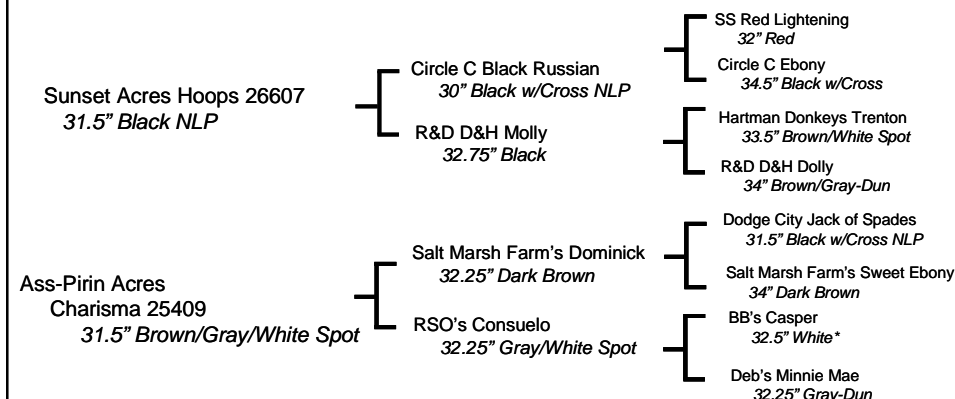

Cheska is a well bred jenny with 5+ generations behind her. Lots of blacks and spots in her line. Well built girl, with quality and balance. She is a little love bug, always ready for a hug. Take a look at her, look at her pedigree, and you will love her.

49 MGF *A La Carte* 822

Black Woolly Jennet, 6/23/08, Reg. #Pending
Consignor: McRoberts Game Farm, 29" Mar 09

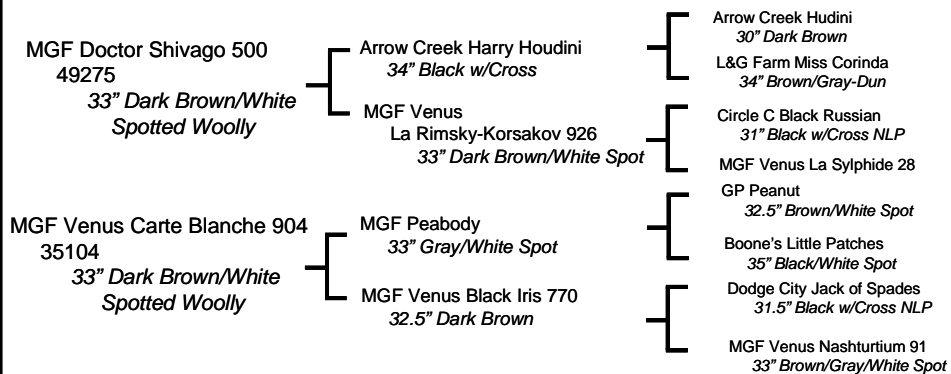

MGF A La Carte is a jet black woolly. She combines woolly genes from both parents. This beautiful girl is another example of the fine quality Shivago is producing.

50 Perfection's *Daylinda*

Black/Brown Jennet, 9/5/07, Reg. #53629
Consignor: Perfection Miniature Donkeys, 19" at Birth

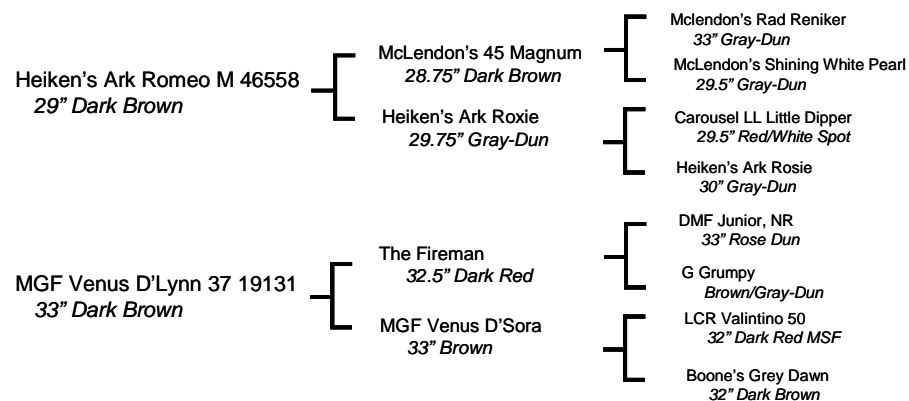

With a pedigree that has all of the old 'who's who' of the donkey world, Daylinda is a pedigree buff's delight. But to top that, she is a real little go getter that loves to please.

51 Ozark *Lil Jill*

Dark Brown Jennet, 5/23/95, 32.75", Reg. #15641

The Elms *Penelope*

Dark Brown Jennet Foal, 6/3/09, 22" at Birth

Consignor: Elms Farm Miniature Donkeys

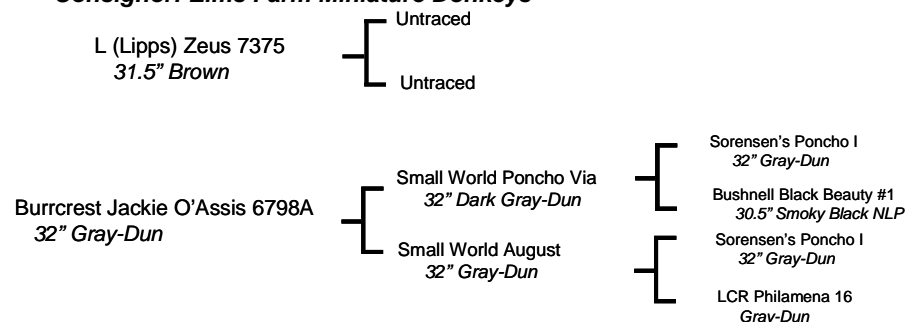

Jill has been an exceptional producer for us, and 5 of her foals have been black. Conformation is great, in her younger days all the show people wanted to buy her. Her sire, Zeus, came from Lipps breeding, an original importer of miniature donkeys with Sorensen's breeding on the bottom side. Her known pedigree is short, but what's shown has lots of quality. We are happily keeping her 07 foal in our herd. Jill has a dark brown jennet foal at side, sired by our loud spotted jack, Geronimo.

52 B. J. *Julie*

Gray and White Spotted Jennet, 8/9/08, Reg. #55682
Consignor: Gold Mine Farm, 20" at Birth

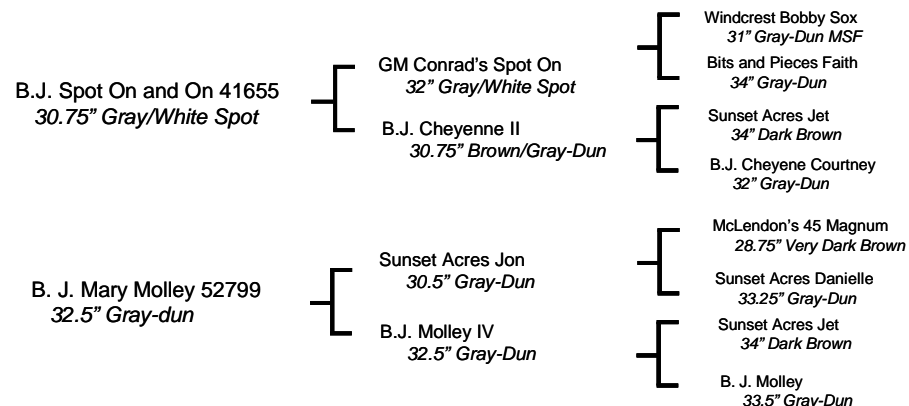

Julie has great conformation and personality. Her loud spots set her apart from the rest of the herd. Notice her small head. B.J Julie will be a yearling by sale time. Remember, you have to grab the really good ones early!

53

Donkarama's *Material Girl*

Light Brown Jennet, 6/17/04, Reg. #Pending, Bred for 2010

Consignor: Donkarama Magickal Farm, 30"

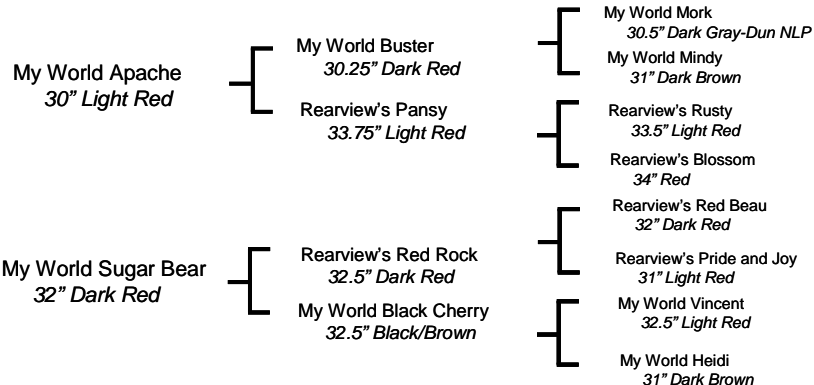

Donkarama's Material Girl, aka Madonna, is truly a breeder's dream. She's a small, mature jennet with wonderful conformation, straight stocky legs and a "Look at Me!" attitude. Her pedigree is loaded with sorrel genetics. She's bred to our dark sorrel jack, Donkarama's Hot Toddy, the last jack offspring of My World Trevor, a Rearview Red Rock son. This little jenny is not to be missed!

54

Sylvandell's *Sapphire*

Gray-Dun Jennet, 12/20/06, Reg. #54559

Consignor: Sylvandell Farms, 32.5" Mar 09

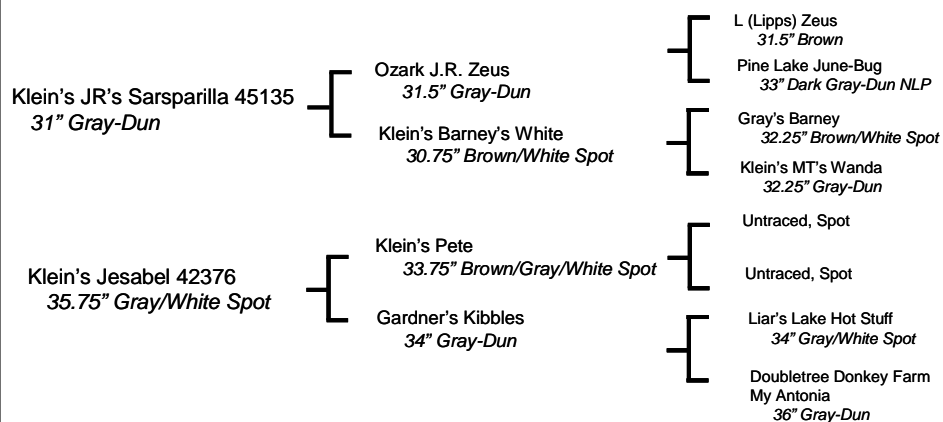

Sapphire lives up to her precious gem name since she's sweet and precious. Her brown highlights and leg garters accentuate her correct conformation.