



Saturday July 26, 2008
Historic Lebanon, Ohio - Fairgrounds

.....
***Select Miniature Donkeys from Breeders
Across North America***

.....
***Quality Conformation, Diverse Pedigrees, All Colors,
Jennets - Yearlings, 2 year olds, Mature, Bred and With Foal
Also A Driving Gelding With Cart & Harness***
.....

**Visit WWW.DONKEYS.NET for
Web Catalog with pictures**
.....

Sale Sponsors
Elms Farm Miniature Donkeys
The Elms Farm
Martha & Dowell Howard
Mason, Ohio
donkeys@donkeys.net
513-398-3341

Welcome To
The Great American Miniature Donkey Sale
Historic Lebanon, Ohio
At the Warren County Fairgrounds

June, 2008

Dear Donkey Enthusiast,

We are pleased to invite you to The Great American Miniature Donkey Sale, a select sale featuring quality registered miniature donkeys. The Sale will take place on Saturday, July 26, 2008 at 12:30 PM, at the Warren County Fairgrounds, next to the Lebanon Raceway, in Building C, in Lebanon, Ohio. We hope you plan to attend.

The Sale will consist of 64 miniature donkey lots. These miniature donkeys have been selected from those offered for consideration. Top breeders are consigning their best, as these donkeys publicly represent their farm and breeding program. It would literally take you many days, and thousands of miles, to view an assortment of available, quality stock like you will see represented at the Sale.

The selected miniature donkeys represent diverse bloodlines, great conformation, and a variety of sizes, colors & ages to attract breeders, show people, and donkey & equine lovers everywhere. Full information on each, including pictures (as consignors make them available), may be found on our web page, www.donkeys.net.

There is something for everyone here, whether you are an experienced breeder, or just getting started. Jennets include; yearlings, coming 2 year olds, mature jennets, bred jennets, and jennets with foals on the side. A trained driving gelding with cart & harness is also being offered. Donkey tack and gifts will be available. Whether you are looking for a single jennet, a jennet with foal, brood jennets for your breeding program, or a loving pet, you are assured of finding only quality miniature donkeys at this sale.

This Donkey Sale is more than just an auction; it is an event, a 'happening'. Donkey enthusiasts everywhere look forward to events such as this and we expect a large turnout from across the Continent. It is an opportunity for folks, both those with years of experience, and those first exploring miniature donkeys, to get together, share experiences, learn from each other, have some fun, make new friends, renew old friendships, and, oh yes, see, bid on, and purchase some of the finest quality miniature donkeys in North America

We hope you plan to attend this year's Great American Miniature Donkey Sale. We are confident you will enjoy it.

Thank You for Your Support

Martha L. Dowell Howard

Phone Bidding – If you can't attend, but want to bid on the donkeys, please contact us on or before July 23 to discuss phone bidding, earlier is better.

Sale Day Telephones 513-225-1771 and 513-919-5613.

The Great American Miniature Donkey Sale
Schedule of Events

FRIDAY JULY 25, 2008 SALE SET-UP DAY

Friday is primarily a set-up and check-in day for the Sale. All donkeys must be on site by 4:00 to allow for consignor and vet check-in. There will be limited viewing during the late afternoon. Events are planned as follows:

Viewing Begins	3:00
Consignor's Invitational Dinner	6:00
Measurement	7:00

SATURDAY JULY 26, 2008 SALE DAY

Saturday is the Sale Day. Viewing will begin at 8:00. Breakfast & lunch will be available for purchase. The Donkey Sale starts at 12:30 and checkout begins shortly after the last lot is sold. Donkey tack, gifts, useful items and curios will be available.

Viewing Starts	8:00
Sale Vendors	9:00
Sale Starts	12:30
Payment, Vet Papers	Shortly after last lot is sold
All Donkeys Removed	before 8:00 PM

SALE LOCATION & DIRECTIONS

The Sale will be held at the Warren County Fairgrounds, Bldg C, adjacent to Lebanon Raceway located on Route 48, 0.7 miles north of the town center of Lebanon, OH. The street address is 660 N. Broadway, Lebanon OH 45036. The Lebanon Raceway, a private company, will be in operation, so no parking on paved areas. Parking for the Sale will be indicated.

From I-75, take exit #29 (Monroe, Lebanon, Rt 63) east to Lebanon, 7 miles. Turn left on Broadway (Rt 48 North), go 0.7 miles to the Fairground.

From I-71, take exit #28 (Rt 48), turn North, go about 2 miles to Rt 123, exit west toward Lebanon, go 1 mile, turn right on Broadway, go 0.7 miles to the Fairground

Auctioneering & Clerking

Kevin Wendt, Auctioneer

5550 Kinvarra Lane

Dublin, OH 43016

614-789-1627 office

419-566-1599 cell

www.thewendtgroup.com

kevin@thewendtgroup.com

The Great American Miniature Donkey Sale

TERMS AND CONDITIONS

Terms: Terms of the sale are cash, good check, or credit card (surcharge) with photo ID. All donkeys must be paid for immediately at sale end. No donkeys may be removed before payment or Sale close. All donkeys must be removed by 8 PM. (We can help if you want to attend / phone bid, but won't have a trailer at the Sale.)

Bidding: All donkeys sell to the highest bidder. Any disputes or challenges will be settled by the auctioneer, and his decision will be final. The auctioneer may reject any or all bids. Bids are per lot. Jennets with foals on the side sell as one lot.

Risk: Owners assume all risk for their donkey up to the point of sale. Buyers assume all risk at the moment the auctioneer declares the donkey sold. Under Ohio Law, all persons attending the Sale do so at their own risk. The Management, their staff, auctioneers & their staff do not assume responsibility for, and disclaim any liability of any kind for; accidents, loss (also animals), and/or personal property damages.

Announcements: Sale day announcements from the auction block take precedence over the material in the catalog or on the web. Every effort has been made to ensure the accuracy of the catalog and web material. However, we assume no liability for errors or omissions from any source.

Contract: The management, auctioneers, and employees act as agents for the seller, but assume no liability for either the buyer or the seller. Any representations made by the sales management are made on behalf of the seller.

The above terms and conditions shall constitute a contract between the buyer and the seller of each animal sold. All guarantees are between buyer and seller.

Health: The EIA/Coggins test will be less than 3 months old. Current health papers for transportation will be good for 7 days past sale date. Proof of pregnancy from a veterinarian is required for bred jennets, otherwise sold as exposed. **Buyers are responsible to obtain the paperwork they need from the veterinarian after payment immediately following the Sale.**

Transport: We may be able to help you get your donkey(s) home. Please let us know if you may need this assistance.

Export: Export buyers will assume all related export costs such as veterinary work, quarantine, shipping, etc. For further clarification, contact us, we export frequently.

General: Please note that information in the catalog has been provided by the consignors. Height data may be birth, immature or adult registered heights and are included only as helpful data. All donkeys will be measured in public view on Friday at the time shown on the schedule. We encourage you to personally inspect the donkeys you are interested in and / or talk with or contact the consignors.

Absentee/ Phone Bids

Please contact Dowell or Martha Howard at 513-398-3341, 513-225-1771, or 513-919-5613, or email at donkeys@donkeys.net by July 23 for details.

Please Bring This Catalog – Supplies Are Limited

The Great American Miniature Donkey Sale

Camping & Lodging

Camping: Camping available at the Fairgrounds for \$20. Water & electric hook-ups, dump station, restrooms & **HOT** showers. 250 ft from the Sale. Pay Martha.

Motels & B&B

	Motel	Miles from Sale	Address	Phone	Web
Lebanon					
	The Golden Lamb	1	27 S Broadway	513-932-5065	goldenlamb.com
	Shaker Inn	2	600 Cincinnati Av.	513-932-7575	shakerinnmotel.com
	Hatfield Inn B&B	5	2563 Hatfield Rd	513-932-3193	bbonline.com/oh/hatfield/
Mason (I-71, Exit 25 - Rt 741)					
	Kirkwood Inn	9	4030 S US Rte 42	513-398-7277	kirkwoodinn.com
	Super 8 Motel	9	5589 Kings Mills Rd	513-398-8075	super8.com
	Hampton Inn	9	5323 Beach Blvd	513-459-8900	hamptoninn.com
	Comfort Suites	9	5457 Kings Center Dr.	513-336-9000	comfordsuites.com
	Best Western	9	2793 WaterPark Dr.	513-754-1166	bestwestern.com
	Microtel Inn Suites	9	5324 Beach Blvd	513-754-1500	microtelinn.com
Mason (I-71, Exit 19 - Fields Ertel Rd)					
	Days Inn	15	9735 Mason Montgomery	513-398-3297	daysinn.com
	Red Roof Inn	15	9487 Bardes Rd	513-398-3633	redroof.com
	Hyatt Place	15	5070 Natorp Blvd.	513-754-0003	hyattplace.com
	La Quinta	15	9918 Escort Drive	513-459-1111	lq.com
	Marriott	15	9664 Mason Montgomery	513-459-9800	marriott.com
West Chester (I-75, Exit 19 - West Chester)					
	Marriott	17	6189 Mulhauser Rd	513-874-7335	www.marriott.com
West Chester (I-75, Exit 22 - Tylersville Rd)					
	Wingate Inn	14	7500 Tylersplace	513-777-1101	www.wingateinn.com
Monroe (I-75, Exit 29 - Rt 63)					
	Howard Johnson	8	150 New Garver Rd	513-539-9221	www.hojo.com
	Comfort Inn	8	120 Senate Dr	513-539-2660	www.daysinn.com
	Hampton Inn	8	40 New Garver Rd	513-539-4400	www.hamptoninn.com

Elms Farm Miniature Donkeys

We strive to produce quality miniature donkeys with excellent conformation, great dispositions and personalities

- * **Correct, drafty donkeys, with emphasis on sorrels, blacks, & darks.**
- * **Large sorrel herd, one of the most genetically diverse anywhere.**
- * **Herd Sires - 4 Sorrels, 3 Blacks, 1 Spot**
- * **Every foal carries sorrel or black genes or both.**
- * **Breed stock selected from herds across North America**
- * **Each mating planned to strengthen desirable characteristics.**
- * **Foundation Herd Planning – Export Expertise**
- * **'Shipping Around the Corner or Around the World' SM**

2008 Consignor List

Arcadian Exotics, Paul and Gertrude Suorsa, 133 Branchton Rd.
Slippery Rock, PA 16057, 724-794-3288, ggsuorsa@embarqmail.com
Lots 17, 46

Assphalt Acres, Steve and Jill Crim, 3640 N 775E, Manilla, IN 46150,
317-402-3958, assphaltacres@yahoo.com, www.assphaltacres.com,
Lot 32

Ass-pirin Acres, Marshlyn and Michael Reed, 4241 VT Rt. 17W, Addison, VT
05491, 802-759-2665, minidonk@together.net, www.asspirinacres.com,
Lots 2, 38, 54

Bainbridge's Long Ears Acres, Sandy Bainbridge, 60 Harker Rd.
Chesterfield NJ 08515, 609-324-0903, sabains@aol.com,
www.bainbridgeslongearsacres.com, **Lots 22, 56**

Big River Miniature Donkey Farm, Jeff and Brenda Runge, 2236 M-A-M
Trail, Monmouth IL 61462, 309-734-6728, bjrunge@maplecity.com,
www.bigriverdonkeys.com, **Lots 19, 47**

Daddy's Darlin' Donkeys, Marion and Jean Sohl, 10180 Faulkner Rd.,
Cleveland TX 77328, 281-592-7002, masohl@sbcglobal.net,
www.daddysdarlindonkeys.com, **Lots 16, 61**

Elms Farm Miniature Donkeys, Martha and Dowell Howard, 5600 Bethany
Rd., Mason, OH 45040, 513-398-3341, 513-225-1771, 513-919-5613,
mhoward@eos.net, www.donkeys.net, **Lots 1, 12, 18, 25, 36, 42, 53, 64**

Gold Mine Farm, Jerry and Barb Persinger, 21 Kuester Lake, Grand Island,
NE 68801, 308-380-0623, jpersinger4@aol.com, **Lots 23, 49**

Heiken's Ark, Dick and Kathy Heiken, PO Box 35456, Des Moines, IA
50315, 515-962-0667, heikensark@aol.com, www.HeikensArk.com,
Lots 7, 31, 59

Hill Country Miniatures, Ed and Angela Preston, 339 E. Town East Blvd.,
Sunnyvale, TX 75182, 972-226-6386, 817-729-7700,
draughonpreston@aol.com, www.hillcountryminiatures.com, **Lots 14, 44**

Hill's Haven, Bill and Sue Hill, 3305 203rd St., Fort Madison, IA 52627,
319-372-3539, hillshaven@lisco.com, www.hillshavendonkeys.com,
Lots 20, 58

KC's Miniature Donkeys, Kathy Cavanaugh, 202 4th St. N, De Graff, MN
56271, 320-843-2520, kcmn@willmarnet.com,
www.kcminiaturedonkeys.com, **Lots 29, 37**

2008 Consignor List

KZ's Ass-piration Acres, Kim and Don Zellers, 1213 Rt. 23, Wantage, NJ
07461, 973-702-8067, amberz@tellurian.net, www.kzasspirationacres.com,
Lots 15, 39

Long Run Farm, KC and Betty Stegemoller, 3500 Utica Rd., Lebanon, OH
45036, 513-932-1601, longrunminidonks@aol.com,
www.longrunminidonks.com, **Lots 35, 52**

Maxwell Ridge Farm, Peter and Mari Maxwell, 245 New Grafton Rd.,
Caledonia, NS BOT 1B0, Canada, 902-682-3161, max-map@hotmail.com,
Lots 4, 27, 43, 51

Merry-Go-Round Mini's, Marlene Clark, 14500 Van Syckle Rd., Gregory,
MI 48137, grclark@hughes.net, www.merry-go-round-minis.com,
Lots 8, 33, 63

McRoberts Game Ranch, Jerry and Barb McRoberts, PO Box 55, Gurley,
NE 69141, 308-884-2371, jbmrcrob@daltontel.net,
www.mcrobertsgamefarm.com, **Lots 5, 13, 26, 34, 48, 60**

Perfection Miniature Donkeys, Val, Deone, Dakota & Wacey
Townsend, RR1 Site 7, Comp 14, Sylvan Lake, AB T4S 1X6 Canada,
403-887-2285, cell 403-350-7959, lsangus@telusplanet.net,
Lots 6, 11, 28, 40, 50, 62

Red Barn Miniatures, Jackie H. Woods, 528 River Rd., Church Hill, TN
37642, 423-357-3454, gwoods@eastman.com, **Lots 9, 57**

Sunset Acres, Bob and Cindy Loewenstein, 1103 Sunset Ave., Grand Island,
NE 68801, 308-382-7474, sunset@minidonkeys.net, www.minidonkeys.net,
Lot 24

Treworlas Farm, Larry Dingle, RR2, Box 520A, Fayetteville, WV 25840,
304-640-3631, larrydingle@hotmail.com, www.treworlasfarm.com,
Lots 30, 45

Wee Ones Farm, L.J. and Deb Mix, 163 Village Green Rd., Gallatin, TN
37066, 615-230-2038, 615-519-9331, Weeonesfarm@aol.com,
www.weeonesfarm.com, **Lot 3**

Willmann West Prairie Farm, Gene and Betty Willmann, 5455 West
Prairie Dr., Belleville, IL 62220-5001, 618-235-0221, 618-578-9676,
gene.willmann@sbcglobal.net, www.westprairiefarm.com. **Lots 21, 41**

West Ridge Acres, Paula Gattis, 12036 West Ridge Dr., Huntsville, AL
35810, 256-852-9117, rpgattis@aol.com, www.westridgeacres.com,
Lots 10, 55

1

LER *Knite-N-Gail*

Very Dark Brown Jennet, 3/25/04, 33", Reg. # 41166, Bred for 2009

The Elms *J.Singer Sargent*

Black w/Cross Jack Foal, 4/24/08, Reg. # Pending

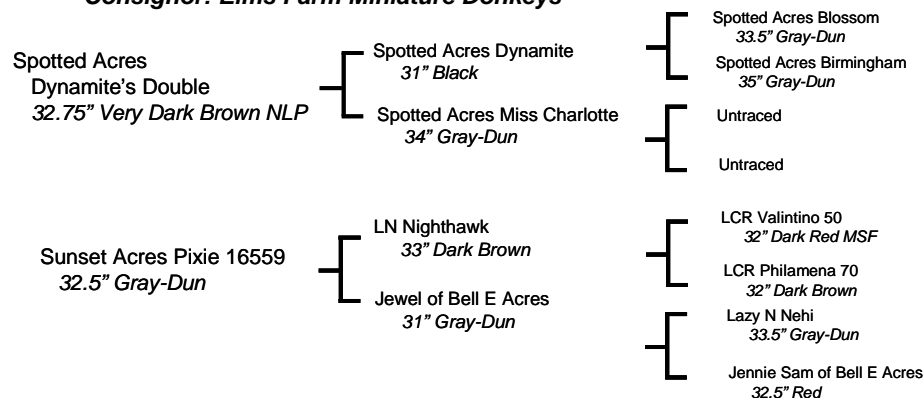
Consignor: *Elms Farm Miniature Donkeys*

Knite-N-Gail is a quality, gentle jennet, and we love her personality. We kept our first two jennet foals by The Elms Rembrandt (31 7/8" black) in our herd. We offer Knite-N-Gail and Sargent, her stud quality jack foal, to show the caliber of Rembrandt's offspring. She will be bred back to Rembrandt, for a 2009 foal.

2

Ass-Pirin Acres *Analiza*

Dark Red Jennet, 7/18/07, Reg. # 52355

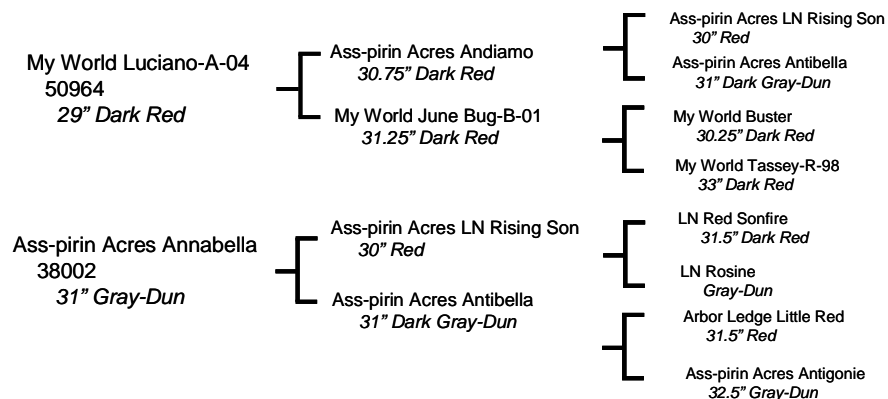
Consignor: *Ass-Pirin Acres, 20.5" at Birth*

We are so pleased with this first foal by My World Luciano. She is small, balanced and a beautiful sorrel color. Analiza is the kind of donkey we like to hold to our herd. She will make you proud in the show ring or in the breeding pen when she is mature. A correct, small sorrel is not everywhere to be had. If you are a sorrel lover, don't let someone else own her!

3

Wee Ones *Lots of Dots*

Black and White Spotted Jennet, 8/12/05, Reg. # 44751

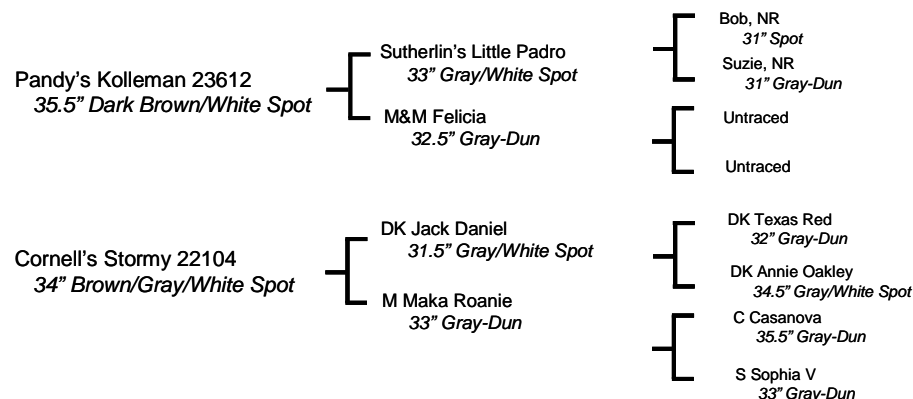
Consignor: *Wee Ones Farm, 31.5" March 08*

Dottie is the product of champion breeding and is the 2006 and 2007 Reserve ACOSA National Champion and Color Class winner in Shelbyville, TN. Dottie is trained for show and a standout everywhere she goes. Her sire and dam were both first in their class and both 2001 Reserve ACOSA National Champions. Here is a chance to get a Champion with the hard to get tyger spotting pattern. Dottie will be 3 in August.

4

The Elms *Sedona Red*

Dark Red Jennet, 5/6/04, 31", Reg. # 39179

Maxwell Ridge *Sedona Rose*

Red Jennet Foal, 5/28/08, Reg. # Pending, 18.5" at Birth

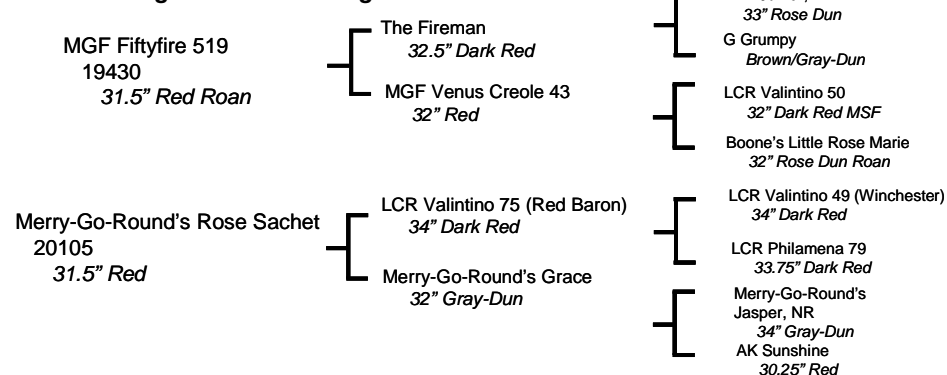
Consignor: *Maxwell Ridge Farm*

What's in a name? Let's see... The Fireman, Red Baron, Red Lightening, Foxworthy, Nicolodeon, Little Motown. This combination has it all. Sedona Red is a pretty, stylish and petite jennet, with a small sorrel jennet foal on the side by 31.5" Yorkleigh Farms Lone Ranger. With all these "names", color, conformation and excellent genetics, Sedona Rose is going to be a winner.

5

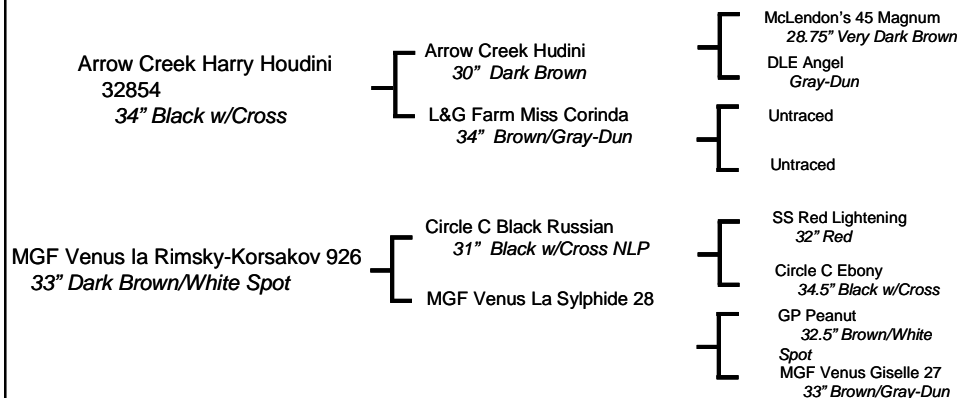
MGF *La Doncella 890***Dark Brown MSF Woolly Jennet, 6/1/07, Reg. # 52746****Consignor: McRoberts Game Ranch, 32" March 2008**

This beautiful jennet has quite a pedigree! By Arrow Creek Harry Houdini and MGF Venus la Rimsky-Korsakov, La Doncella is a full sister to Ebony and Ivory, the high seller at this Sale 3 years ago. Our current breeder, Doctor Shivago, is also her full brother. In addition to her great genes, she has bone, wool and color.

6

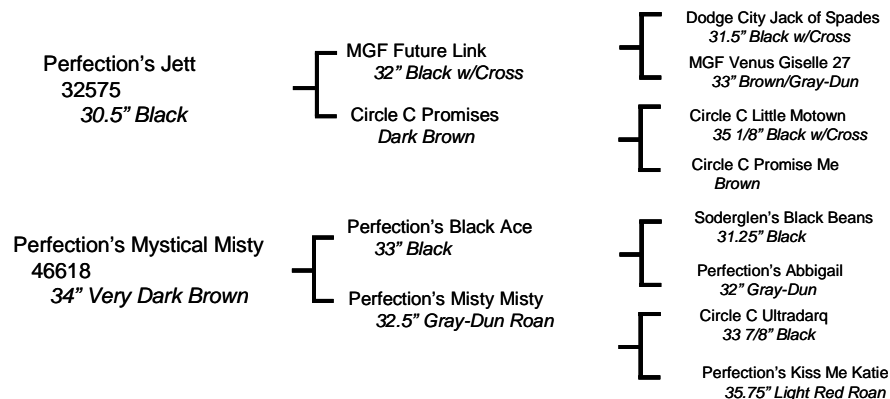
Perfection's *Charmin Misty***Black Jennet, 6/1/07, Reg. # Pending****Consignor: Perfection Miniature Donkeys**

Charmin Misty is a color powerhouse, blacks and roans all the way through in this sweetheart's pedigree. Wrapping up 2 of our best maternal lines with the great Jett has produced a jenny that will continue on to greatness either in the show ring or the breeding field. Black as Black and sure to cause a stir, you definitely need a "Misty" in your breeding herd.

7

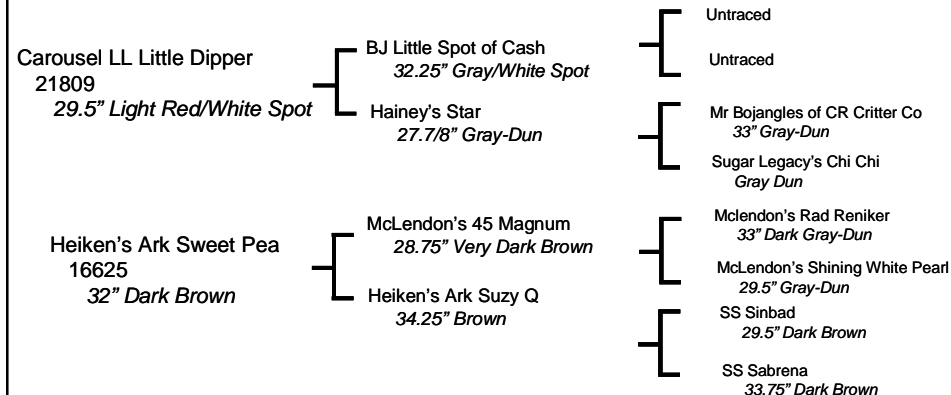
Heiken's Ark *Simone LD***Gray and White Spotted Jennet, 6/9/07, Reg. # 52434****Consignor: Heiken's Ark, 20.5" at Birth**

Here is a yearling spot with great potential. She is a Magnum granddaughter and the daughter of our 29.5" spotted herd sire, Little Dipper. She was only 20.5" tall when she was born. Tuck her away in your herd, breed her to a dark jack, and have her produce that flashy brown or black spotted foal you want!

8

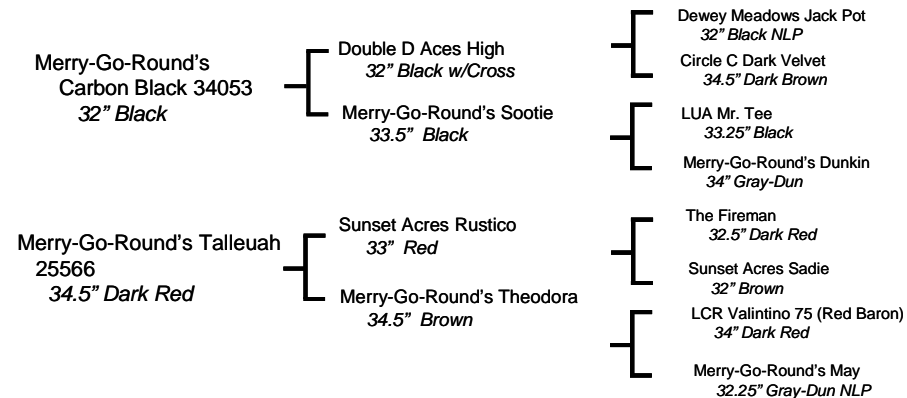
Merry-Go-Rounds *Eye Candy***Dark Brown Jennet, 5/15/06, Reg. # 49023****Consignor: Merry-Go-Round Mini's, 32.5" March 2008**

Candy is a sweet jennet with good bone and good conformation. She has multiple generations of my breeding in her pedigree. Great jacks like Rustico, The Fireman, Red Baron, Jackpot and Mr. Tee, and jennets like Sootie, one of my best black jennets, fill her pedigree. Candy will be an asset to any breeding program with blacks or sorrels.

9

RBM *Bobbi Sue*

Red Jennet, 7/25/06, Reg. # Pending

Consignor: Red Barn Miniatures, 19.5" at Birth

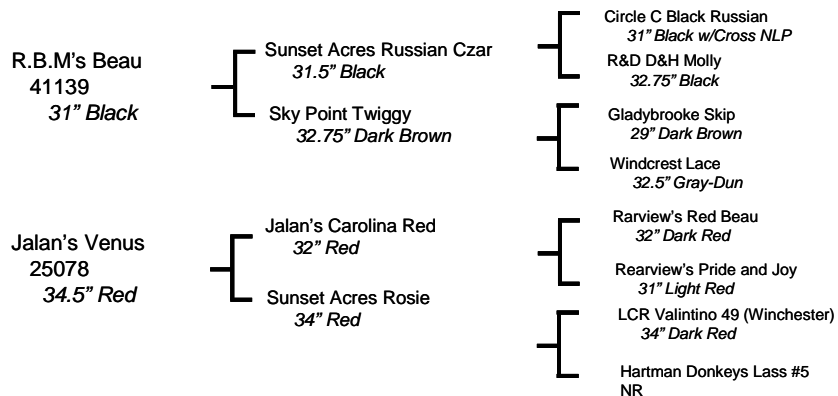

Bobbi Sue has beautiful dark red color and good conformation. Out of Venus, this 2 year old is darker than her dam. Plenty of blacks and reds in the pedigree. She measured 31.5" in March 08.

10

Sunset Acres *Sugar Fire*

Red/Gray Jennet, 5/14/00, Reg. #31410, 32.5"

West Ridge *Tickled Pink*

Light Red Jennet, 5/2/08, Reg. # Pending, 21.5" at Birth

Consignor: West Ridge Acres

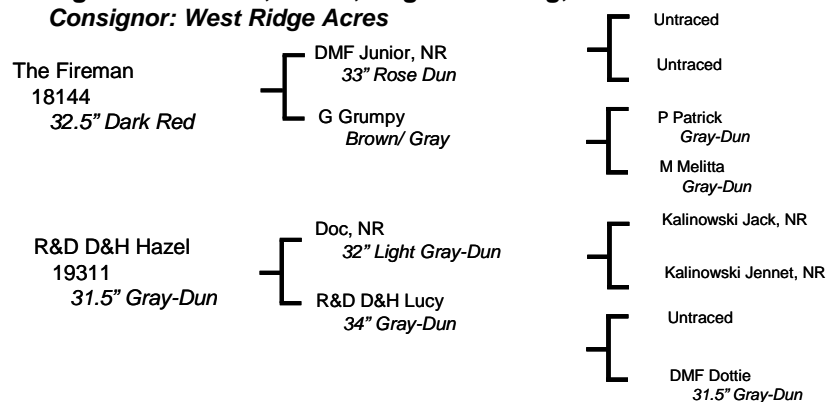

Sugar Fire is a daughter of the legendary Fireman! She has a beautiful head, straight legs, and a nice round rear end. Sugar has a gentle disposition, and is easy to handle. She produced a beautiful red foal in '06. Tickled Pink is sired by HHAA Riff Raff (Red/Brown by PGF Peppercorn Jack, out of Windcrest Copper Penny). Riff placed 3rd in Foals to Halter at the '03 Great Mule and Donkey Show, and 6th in '04. Sugar Fire sells open to breed to your jack.

11

Perfection's *Im In Love*

Brown NLP Jennet, 6/26/06, Reg. # 50132

Consignor: Perfection Miniature Donkeys

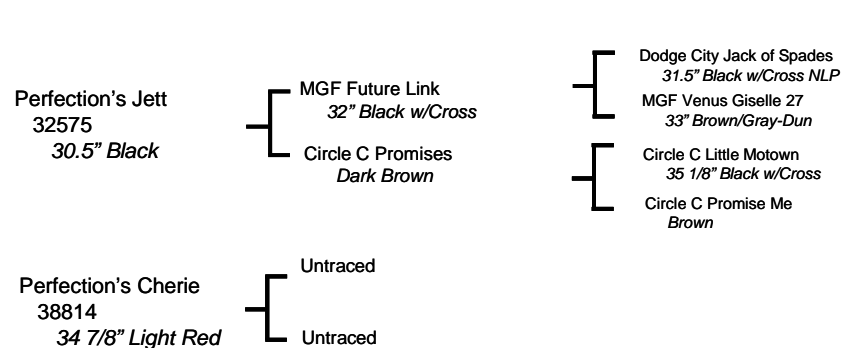

Mon a me Cherie', I am in love with you my friend! A true sweetheart, this stocky grulla 2 year old combines the "quarter horse butt" of Cherie' with the legendary Jett. A beautiful color and a great jennet to start your own grulla line.

12

The Elms *Little Minibrays*

Dark Brown Jennet, 9/21/07, Reg. # 51996

Consignor: Elms Farm Miniature Donkeys, 21" at Birth

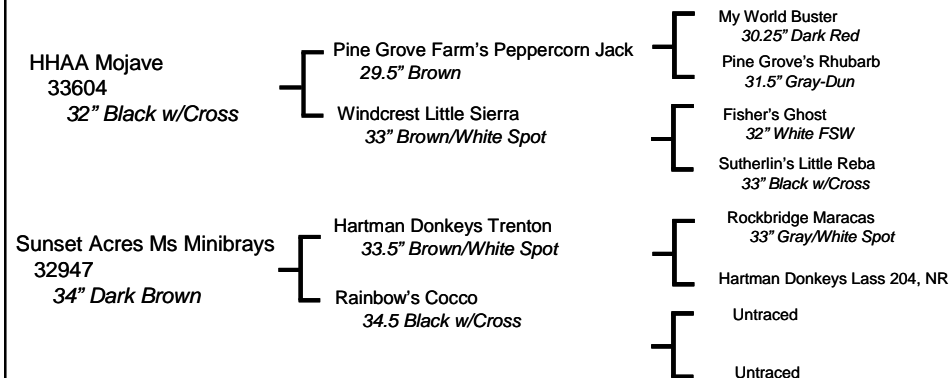

Here's a gem of a jennet in a striking dark brown color. She is from Mojave's first foal crop, and we can see that he gives his pretty head to his foals, with great conformation. She moves with style and has a great profile. Lots to like with this super jennet!

13

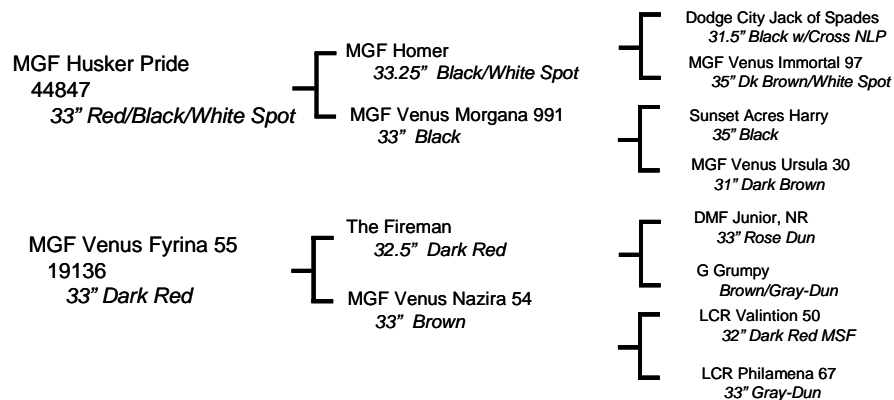
MGF Fyre'n Ice 780**White/Red Frosted Spotted Jennet, 7/30/07, Reg. # 52745****Consignor: McRoberts Game Ranch, 28" Mar 2008**

This type, small, very correct jennet is one of the first Husker Pride sorrel spots we have offered. She has some interesting genetics with her dam, MGF Venus Fyrina, being a Fireman daughter. With her great color and conformation this adorable little girl will be hard to beat!!

14

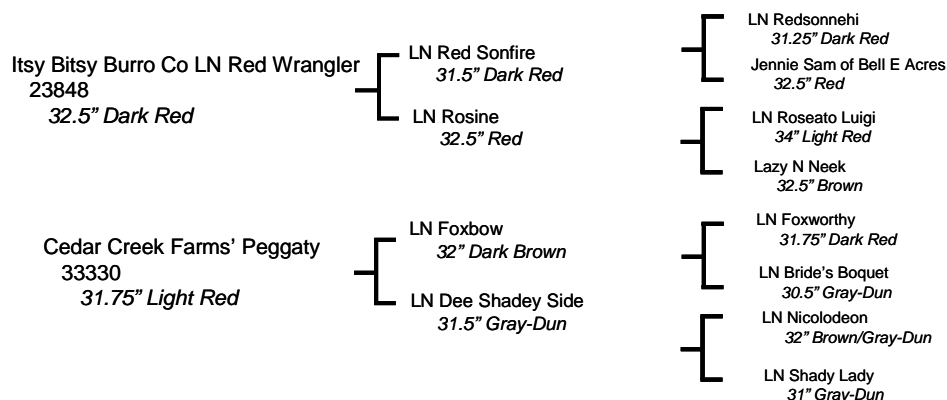
Designer Donkeys Autumn**Dark Red Jennet, 10/14/05, Reg. # 44278****Consignor: Hill Country Miniatures, 31" May 08**

Autumn is a 31" balanced, dark red jennet with a dynamite pedigree. She placed first in Shelbyville Yearling Jennets 2007, and second at the SDMS Spring Fling. We'll definitely repeat this pairing!

15

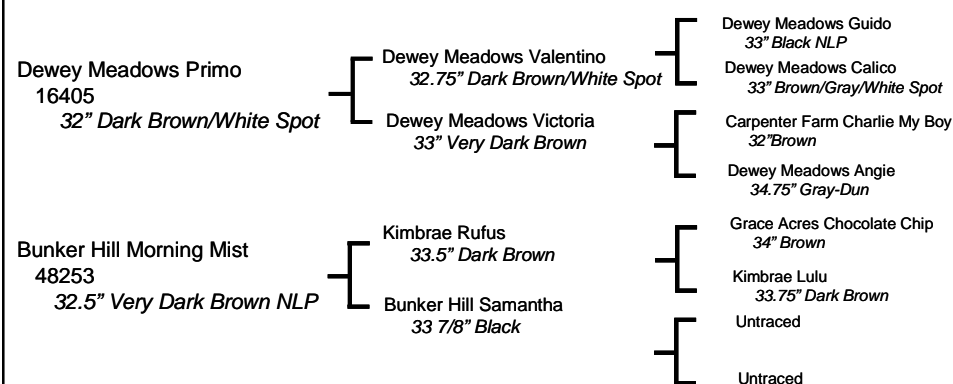
KZ Radiance In The Mist**Black Jennet, 9/29/07, Reg. # 51189****Consignor: KZ's Ass-piration Acres, 21" at Birth**

Radiance is a beautiful, small, compact, dark little jennet by our well known dark spotted herd sire Primo. Primo foals speak for themselves, as many breeders in the US and Canada own some of his offspring. Here's your chance to add one of his best daughters to your herd.

16

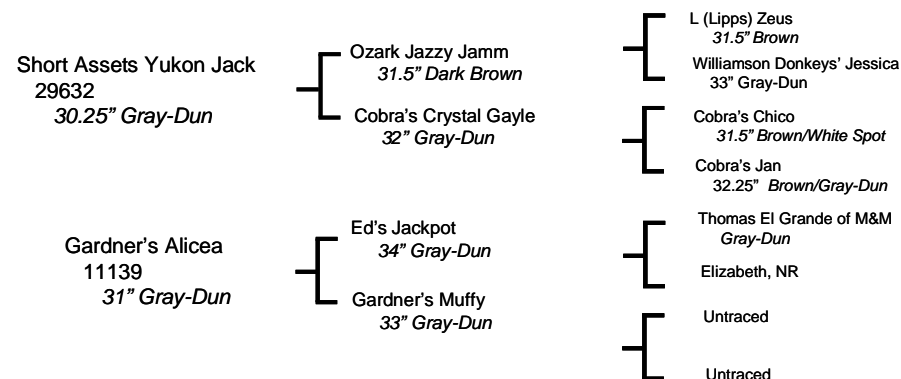
Daddy's Annie**Gray-Dun Jennet, 6/20/05, Reg. # 52466****Consignor: Daddy's Darlin' Donkeys, 29.75" at 2 1/2 yrs.**

If you like tiny, here she is. Pedigree includes Ozark's Jazzy Jamm, L Zeus, Cobra's Chico, and Rainbow's Blizzard. 3 years old, open, ready to breed to your little jack.

17

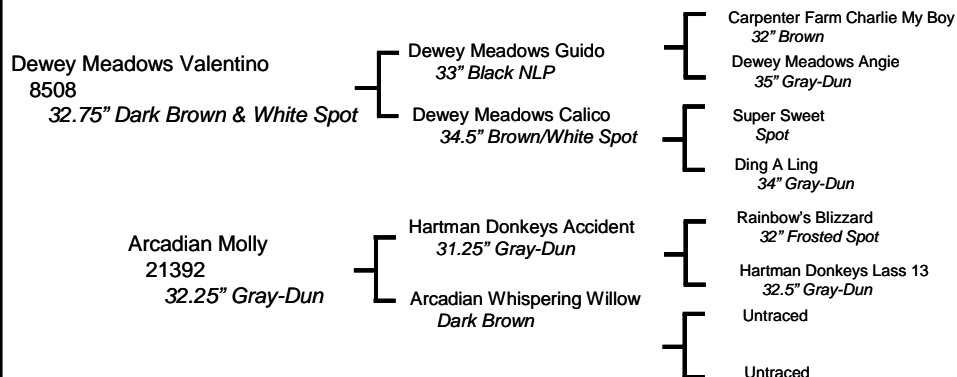
Arcadian *Michaela***Brown & White Spotted Jennet, 9/29/07, Reg. # 52525****Consignor: Arcadian Exotics, 26 3/8" Mar 08**

Arcadian Michaela is a flashy, frosted brown and white spotted jennet with good legs. She's a real sweet heart. Her dam, a granddaughter of Rainbow Blizzard, has produced numerous outstanding full siblings in a variety of colors which sold quickly. Her sire, DM Valentino, traces to two famous imports, Enrico Caruso and Luigi 95.

18

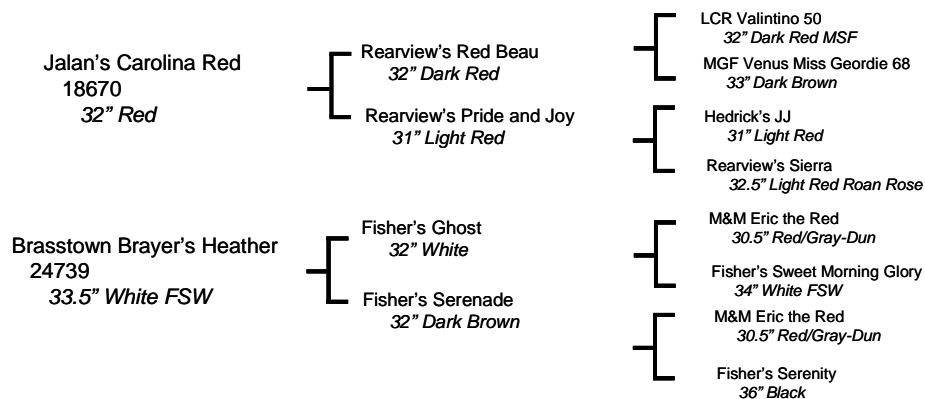
The Elms *Pipsisewa***Dark Brown Jennet, 4/3/07, Reg. # 53017****Consignor: Elms Farm Miniature Donkeys, 21.5" at Birth**

Pippi is built like we like them, straight legs, well filled out, smooth body, pretty head, and balanced. She has a personality that is friendly and willing. Great blood lines. Her dam Heather stays in our herd, and the topside is well represented on our farm, so we feel we can offer her to you.

19

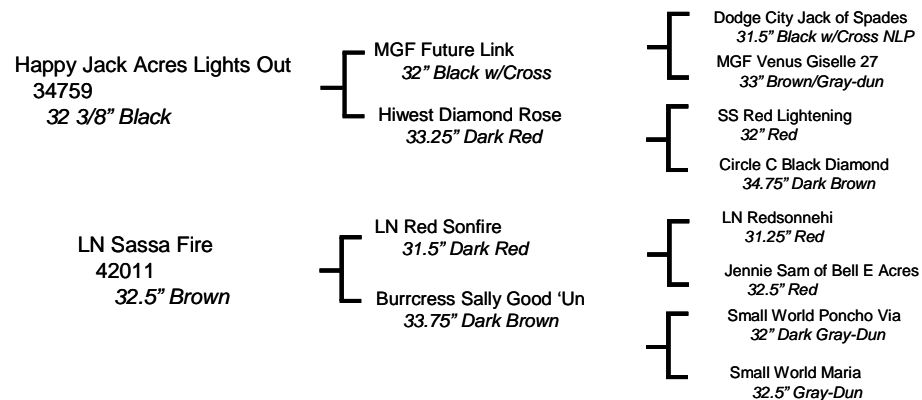
Big River *Esther***Dark Red Jennet, 4/16/06, Reg. # 46004****Consignor: Big River Miniature Donkey Farm, 31.75" Jan 08**

This 2 year old dark sorrel mahogany jennet has it all. Esther is well balanced with a full pedigree loaded with sorrel and black. She is descended from many top quality jacks and jennets recognized by long time breeders. Consider adding this jennet to your breeding program.

20

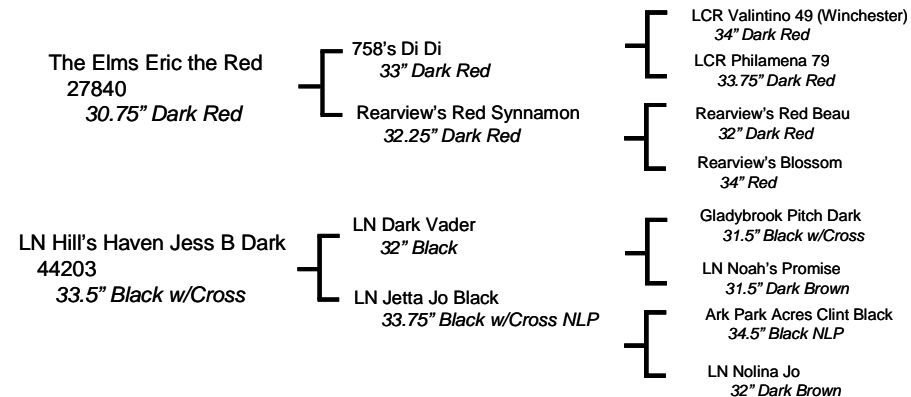
Hill's Haven *Torah***Dark Brown Jennet, 8/31/07, Reg. # 52238****Consignor: Hill's Haven, 27" March 08**

Torah has a strong Black background from her dam, Jess B Dark. Look closely and you'll see very dark Red highlights from her sire, The Elms Eric the Red. If you like Red and Dark Brown or Black, Torah is for you.

21

West Prairie *Andrea*

Gray-Dun Jennet, 9/24/06, Reg. # 52691

Consignor: West Prairie Farm, 30.5" Mar 08



Andrea has a few white hairs on her forehead that highlight her face. She is an exquisite gray dun jenny with a bold black stripe and all great features. She's very gentle and has a great personality. She will be small. Take a good look at this beautiful 2 year old. Don't miss her, you'll love to have her in your herd.

22

Bainbridge's *Poppys Petal*

Dark Brown Jennet, 2/23/07, Reg. # 50919

Consignor: Bainbridge's Long Ears Acres, 30.5" March 08

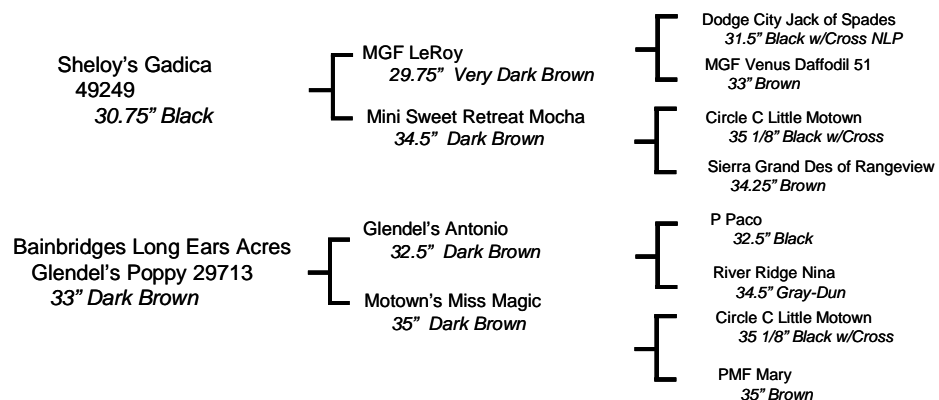

Poppy is a beautiful deep brown. She has a beautiful round rear, straight legs, good bite and great pedigree. What more could you ask for?

23

B.J. *Oprah Girl*

Black Jennet, 6/5/07, Reg. # 51985

Consignor: Gold Mine Farm, 21" at Birth

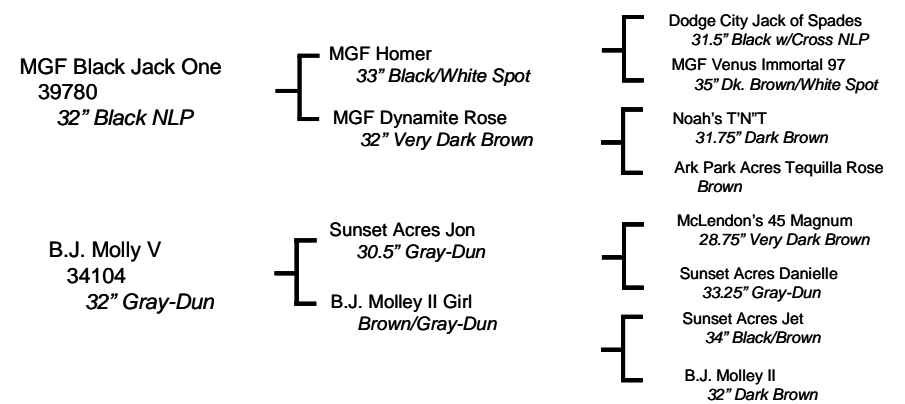

Looking for black? Here she is. Oprah Girl's sire, MGF Black Jack One, is jet black and 32". We expect her to be small as her dam is also 32". Oprah has good conformation and perfect teeth. We think you will be thrilled when you purchase this little girl.

24

Wulff's *Rita Little Maria*

Dark Brown Jennet, 4/27/05, Reg. # 50456

Consignor: Sunset Acres, 30.5", Bred for 2009

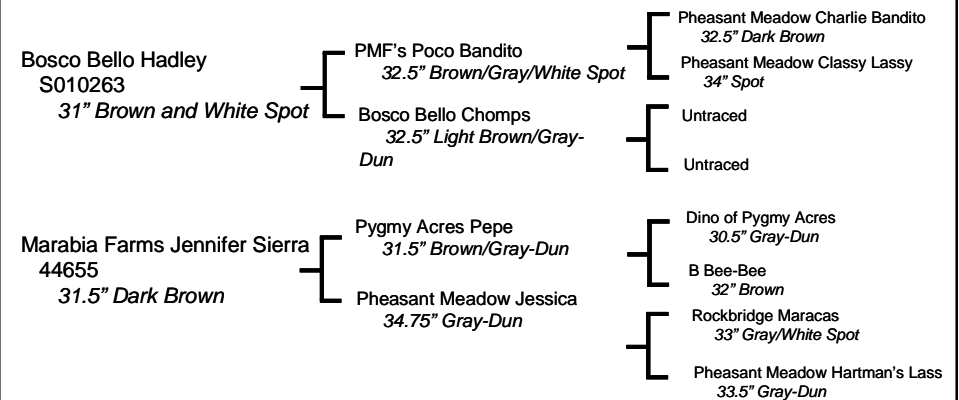

Here's a lovely small dark jennet, and she is bred for Spring 2009 to our new spotted herd sire, Sunset Acres Hotday in July (by MGF Prime Time, out of Sunset Acres Nezi). Hotday is a red, brown and white spot. He has it all, a small and nice pedigree, stocky, color and conformation. Oh boy, what a jack! And what a jenny to pair him with!

25

Suncreek Penny

Black Jennet, 6/28/98, Reg. # 33067

Consignor: Elms Farm Miniature Donkeys, 33.25", Bred for 2009

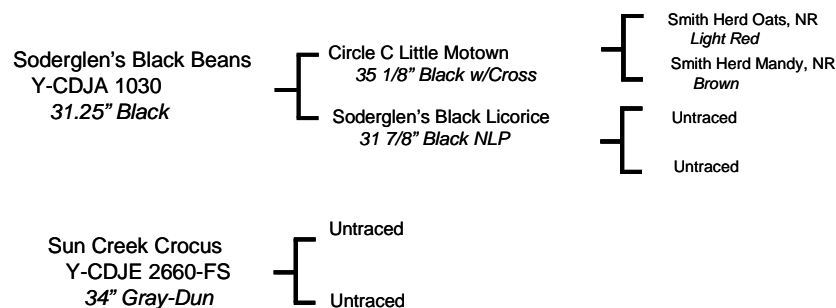

Penny is the blackest jennet you can imagine. She defines black, that's lose her in the coal bin black! Only her beautiful white nose gives her away. Her foals are intense black. 2nd in Halter at Calgary 2001 with a foal at side. We are keeping one daughter and two grand daughters in our herd. We bred Penny to our new dark spot jack, Geronimo, hoping for a black and white foal for you in 2009.

26

MGF Lady Baccarat 799

Dark Brown and White Woolly Spotted Jennet, 8/18/07, Reg. # 52747

Consignor: McRoberts Game Ranch, 26" Mar 08

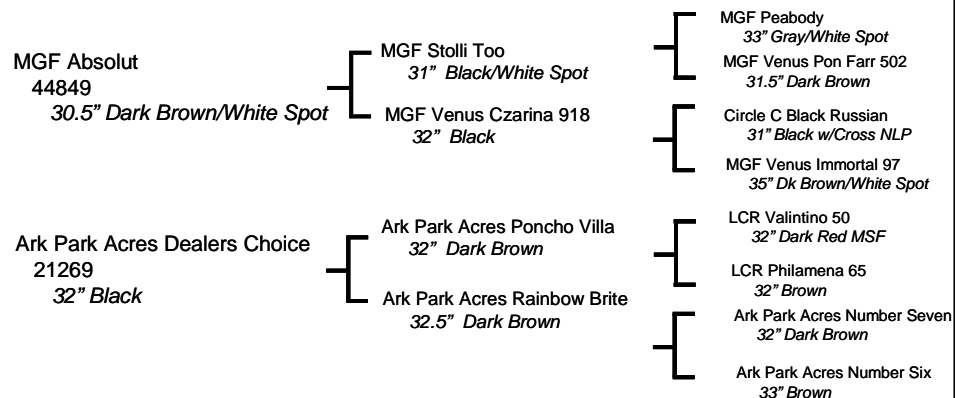

This little jennet is absolutely stunning! Lady Baccarat is out of APA Dealer's Choice and our favorite Stollie Too son - MGF Absolut. This super woolly gal gets her woolly genes from both parents. With her great color & conformation, this adorable little girl will be hard to beat!!!

27

Stoney Acres Katerina

Brown Jennet, 5/19/02, 32", Reg. # CDJE-3887

Consignor: Maxwell Ridge Farm, Bred for 2008

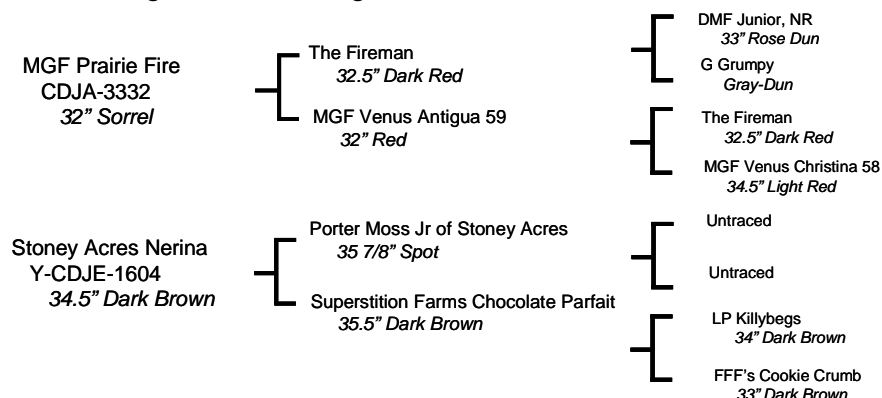

Katerina was 3rd at Stampede in a jennet yearling class of 40+, and 1st at Red Deer Futurity Jennets prize of \$1000. Her sire has an impressive show record (Grand Champion Maturity Jack, Westerner Show '01, Grand Champion Jack at Red Deer MDE in '02). Bred to Yorkleigh Farms Lone Ranger (31.5" dark red, 3rd at Stampede, 2nd at Red Deer) for a May 08 foal. She's a superior jennet in foal to an outstanding jack, with proven show records. How can you miss?

28

Perfection's Misty Morning

Gray-Dun Roan Jennet, 6/11/01, 32.75", Reg. # 46551

Consignor: Perfection Miniature Donkeys, Bred for 2008

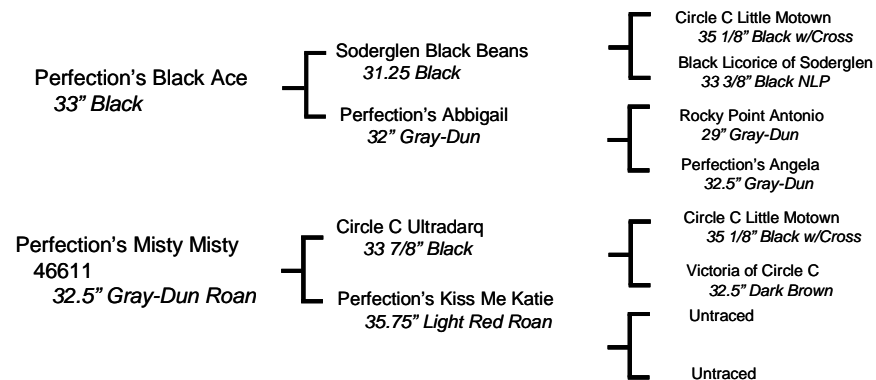

Ouch, it hurts! It's said if an offering to a sale doesn't hurt then you haven't dug deep enough into your breeding program. Well, we dug REALLY deep because the foundation Misty's were to never leave the farm. Misty Morning has been an outstanding producer for us. However you breed her, you'll get a great foal in an exotic color. Bred to Heiken's Ark Romeo M. Don't let this treasure slip by, as I can guarantee a producing Misty won't leave Perfection Farms again!

29

KC's Flicker's Fancy Lady

Dark Brown Jennet, 4/6/07, Reg. # 51679

Consignor: KC's Miniature Donkeys, 29" March 2008

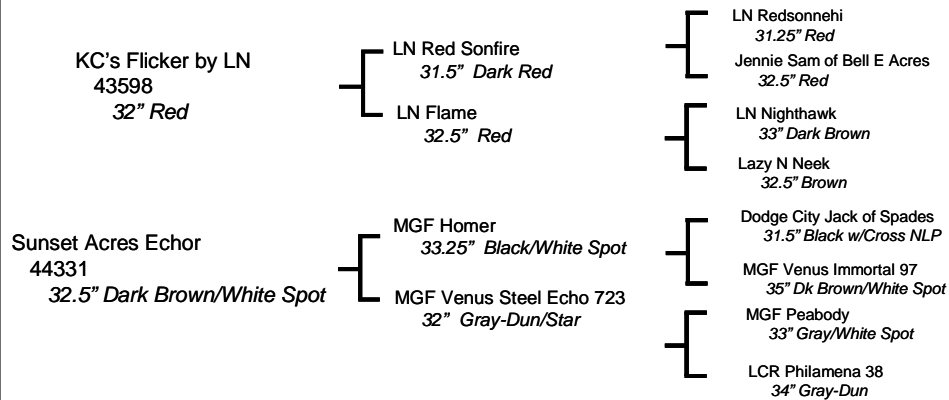

Fancy is a sharp little jennet built like the kind you love to have in your herd. She's stocky, square, and balanced. A rich chocolate dark brown, and a few white hairs in her forehead sets off her exceptional head. Check her pedigree, it is full of proven breeding stock with lots of color.

30

Treworlas Tiffanys Gold

Brown MSF Jennet, 6/30/04, Reg. # 40861, 32" March 2008

Treworlas Best Buddy

Brown/White Spotted Jack Foal, 4/23/08, Reg. # Pending, 20" at Birth

Consignor: Treworlas Farm

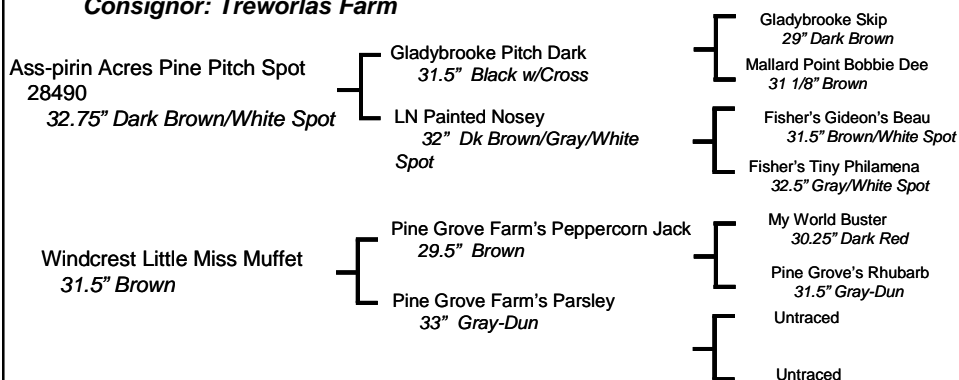

Tiffany's a stocky little jenny with masked spotting factor which proved itself with her April spotted jack foal. Friendly and quiet, with parentage from some famous donkey farms, she will be a fabulous addition to your herd. Her little foal is super friendly and wow'd the pre-school class visit with his eagerness to be petted by all. We hate to part with both of them! The foal's sire is Treworlas Terrific (32.25" dark red, by Ass-pirin Acres LN Rising Son).

31

Heiken's Ark Kjierra T

Very Dark Brown NLP Jennet, 6/1/07, Reg. # 52433

Consignor: Heiken's Ark, 20" at Birth

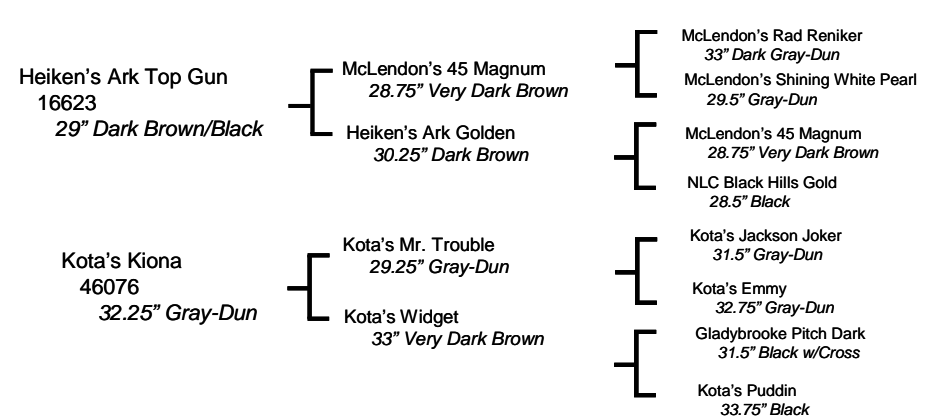

Here is a yearling daughter of Top Gun, with that beautiful "Top Gun" head and his very dark brown color. Her pedigree has lots of black and very dark brown in it. Only 20" tall at birth, so she should mature at a very desirable size. She is a very classy little jennet who would be a great asset to your herd.

32

Assphalt Acres BJ 55

Dark Red Jennet, 9/22/06, Reg. # 52801

Consignor: Assphalt Acres, 30" March 2008

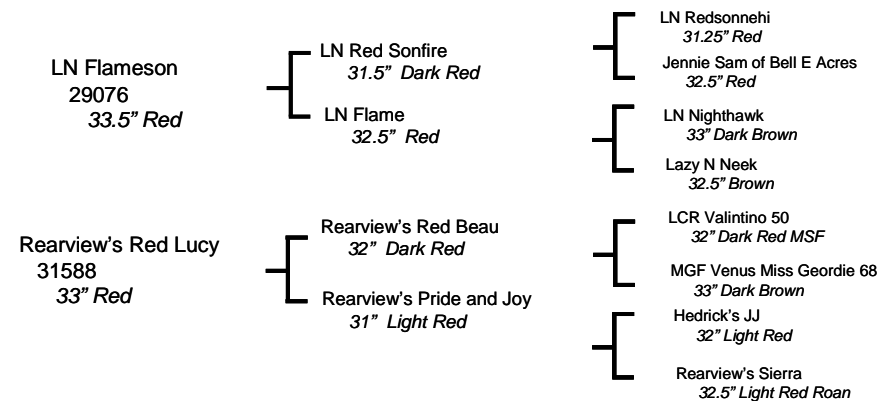

This is what we're talking about! This little Red Beauty will fit into any breeding program. She comes from the well respected bloodlines of Rearview's Red Beau and LN Red Sonfire. This small, compact red jennet should produce many nice red foals for you, her new owner!

33

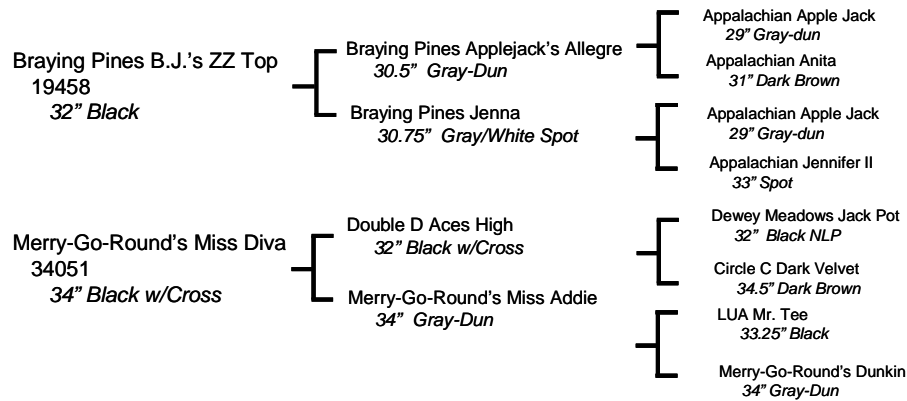
Merry-Go-Round's *Miss Divina***Black Jennet, 8/23/06, Reg. # 49029****Consignor: Merry-Go-Rounds Mini's, 32" March 2008**

Divina is a nice black 2 year old jennet with good bone and color. Her full brother, Who's Your Daddy, 31" at almost 3, has sired 3 gorgeous jennet foals for me, two deep black, and one a dark brown. This gal is a treasure, and valued for any black breeding program.

34

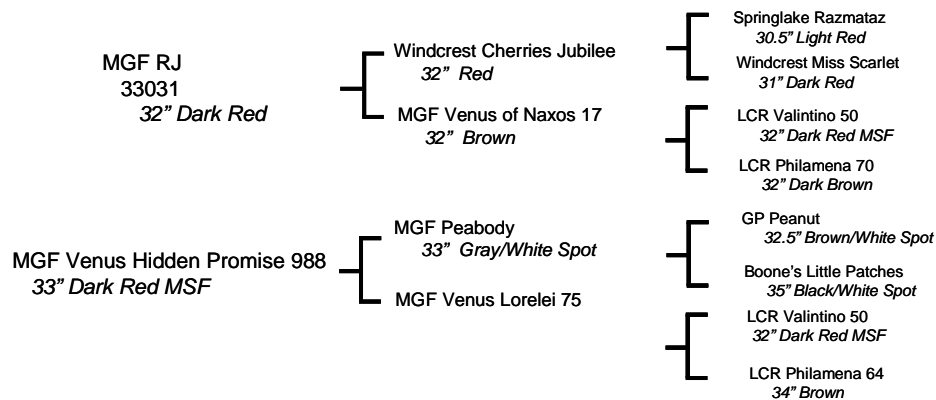
MGF *Promises To Keep 652***Red Jennet, 6/28/06, Reg. # 52764****Consignor: McRoberts Game Ranch, <32" Mar 08**

This beautiful dark red jennet will be one of our last RJ offerings - as we no longer own him. Her mother - MGF Venus Hidden Promise - is also a dark red. A full pedigree with lots of great donkeys. This 2 year old jennet promises to be a keeper!!

35

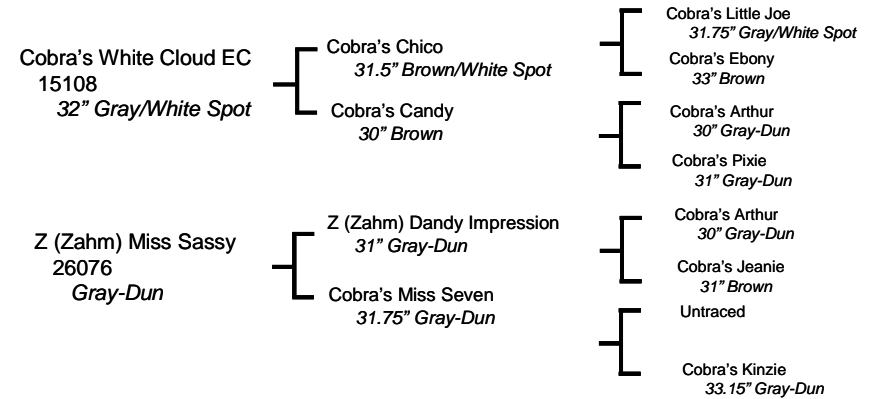
TMD *Thom-Ass Cobra's Comanche***Gray and White Spotted Gelding, 9/20/01, Reg. # 36473****Consignor: Long Run Farm, 32.25" Harness Trained Gelding**

Comanche is a serious show gelding who stands out in halter and performance. He started training last summer and is earning points in ADMS Versatility Hall of Fame and NMDA Ambassador for the Breed. He has a gelding's disposition and presence of a breeding jack. His spots are a bonus. His driving debut, the Lebanon Christmas Parade, had 140 entries, 50,000 spectators & a mile route. He did both day and night parades at a trot, no problem. Sells with cart & harness.

36

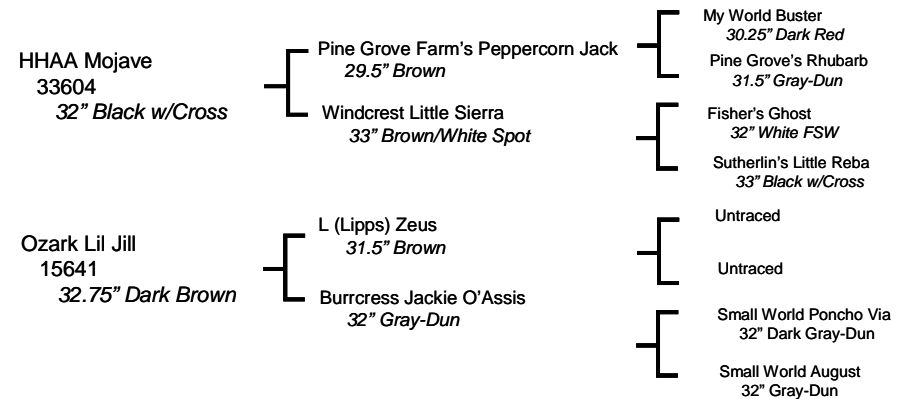
The Elms *Sophia***Black w/Cross Jennet, 9/15/07, Reg. # 51402****Consignor: Elms Farm Miniature Donkeys**

Sophia is our first foal sired by Mojave, and as wonderful as we hoped. Her dam, Jill, has always given us very correct foals with good bone. Sophia is black, stocky and solid. Super straight, and with his beautiful head. She's a good one!

37

KC's Cutie N Red

Dark Red Jennet, 7/20/07, Reg. # 51678

Consignor: KC's Miniature Donkeys, 29.5" March 2008

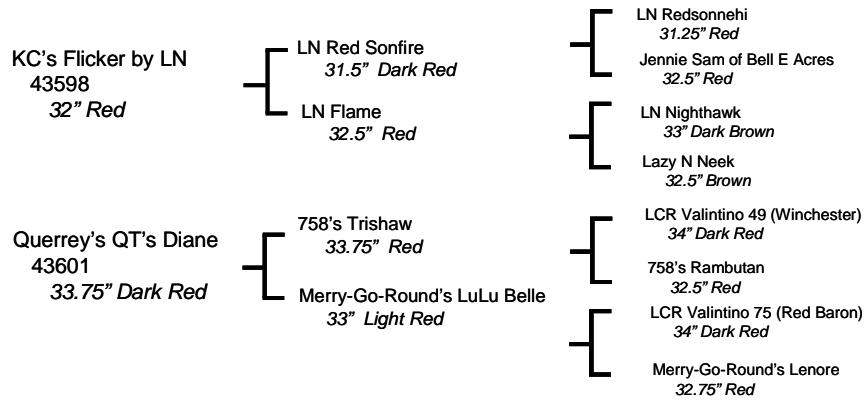

"Cutie" is a flashy dark red sorrel jennet that will catch your eye. Bred to be Red! Nicely built, exceptional head to top off a body that is stocky, straight and well balanced. Check out her pedigree! Lots to offer. Look her over!

38

Ass-pirin Acres Hoshi

Black NLP Jennet, 7/29/07, Reg. # 52357

Consignor: Ass-pirin Acres, 21.5" at Birth

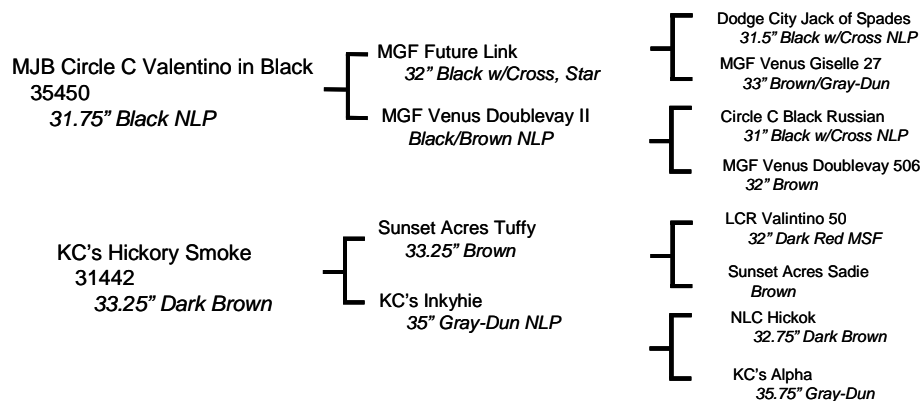

Hoshi is striking in her black coat and a star to boot. Upheaded and proud of herself. She should stay small, but well boned. Hoshi would enhance any black breeding program.

39

KZ Romeo's Enchanting Eve

Gray and White Spotted Jennet, 4/25/07, Reg. # Pending

Consignor: KZ's Ass-piration Acres, 30.75" Feb 08

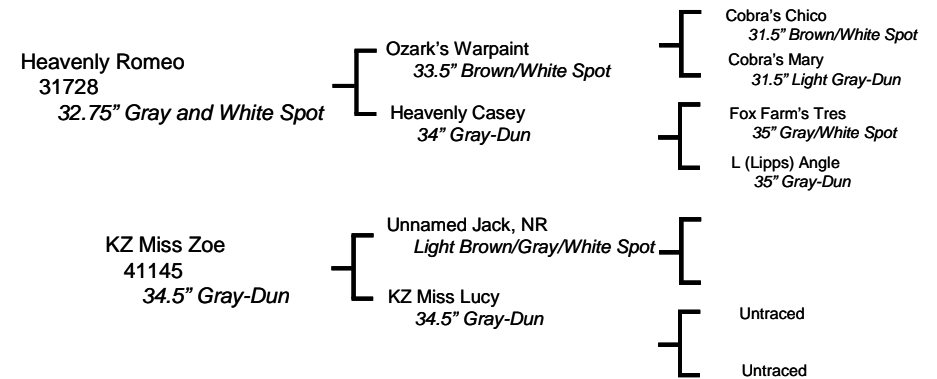

This blocky, spotted jennet is by our herd sire, Heavenly Romeo. Romeo has always produced a thick, well conformed foal for us, and Eve is no exception. Take this one in the show ring and win. Eve would be a great asset in anyone's herd.

40

Perfection's Calypso

Black Jennet, 8/29/07, Reg. # Pending

Consignor: Perfection Miniature Donkeys, 18" at Birth

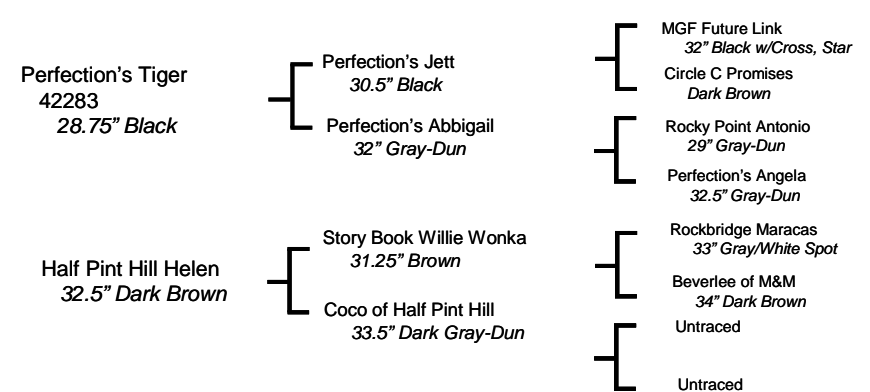

A GODDESS, a NYMPH, whatever you call her she will blow you away. Calypso's built just the way we like 'em; stovepipe legs, small chiseled head, and a great big buddadunk! Her small size, color and great conformation will bewitch you. You will want to be showing her, not against her. Get in on the wave and be the first to own a TIGER!!

41

West Prairie Tina

Dark Brown Jennet, 10/17/06, Reg. # 52692

Consignor: West Prairie Farm, 27" Mar 08

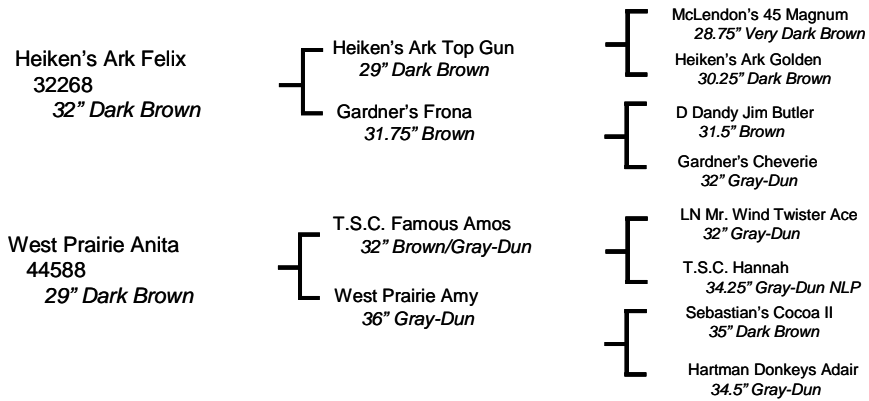

Tina is a great little 2 year old jenny. She has a dark stripe and dark legs with a few white hairs on forehead. She is very gentle, loves attention. She is small, and will stay small, with all the great features. Tina's dam has 2 daughters which only reached 29" tall when full grown. She is one of a kind, take a good look at her. Wonderful jenny, make a great herd addition to all herds.

42

The Elms Red Satin Doll

Dark Red Jennet, 9/30/07, Reg. # 51400

Consignor: Elms Farm Miniature Donkeys, 20.5" at Birth

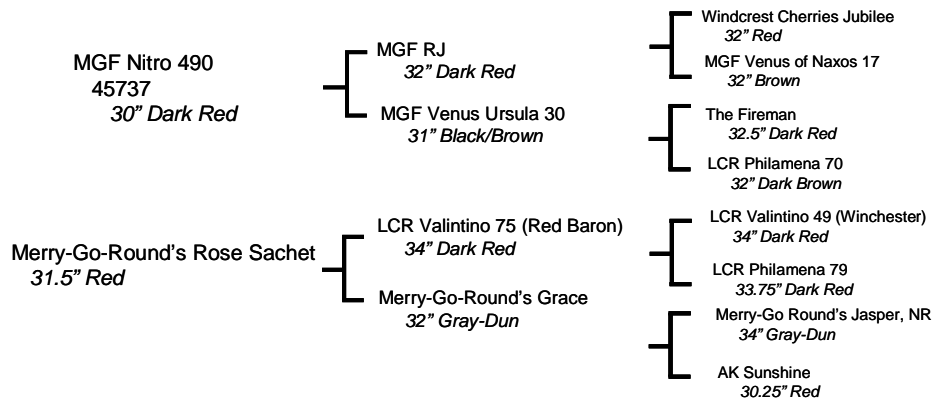

Red Satin Doll is an intense dark red and she's staying small with a super personality. Her mother has had some splendid foals, and 'Doll' is no exception. Her sister, Pebbles, is in our breeding herd and has given us some stunning jennets. Both grandsires are renowned for their wonderful foals. This red jenny can put the 'Dark Red' into your breeding program.

43

Ass-pirin Acres Pat E Cakes

Red Jennet, 8/1/01, 32.25", Reg. # 35505

Maxwell Ridge The Ranger

Red Jack Foal, 4/20/08, 19.5" at Birth, Reg. # Pending

Consignor: Maxwell Ridge Farm

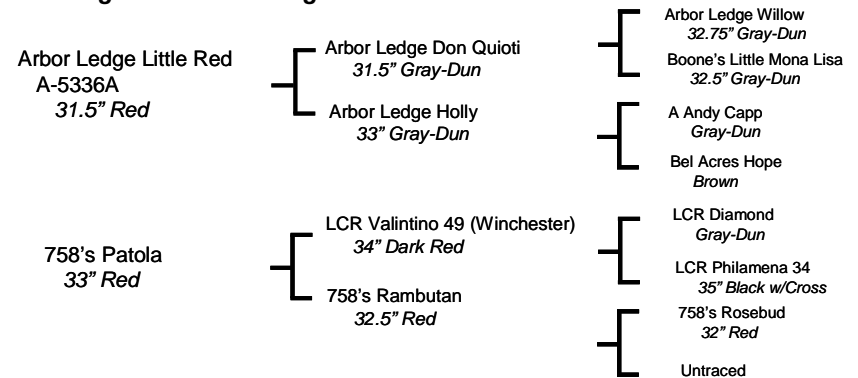

Here's a real deal, a pair with Winchester & Foxworthy sorrel lines. Pat E Cakes has color, quality, temperament, and a very handsome correct jack foal at her side, sired by 31.5" Yorkleigh Farms Lone Ranger (3rd at Stampede, 2nd at Red Deer). This pair will definitely be herd enhancers, true assets.

44

Hill Country Connie Sue

Very Dark Brown Jennet, 2/16/07, Reg. # 48921

Consignor: Hill Country Miniatures, 22" at Birth

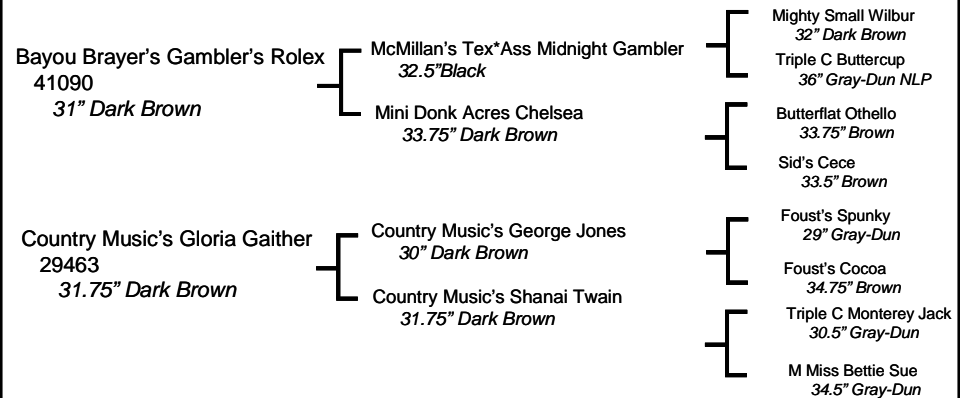

Connie Sue is a beautiful little brown jennet with the trademark George Jones head, and the ability to throw black. She has great conformation, heavy bone, level top line, and straight legs. She is one of the most intelligent donkeys we've raised. Her sire, now in Holland, left just 2 daughters in the US.

45

Treworlas *Magics Beauty*

Black w/Cross NLP Jennet, 7/25/06, Reg. #46815

Consignor: Treworlas Farm, 32" May 08

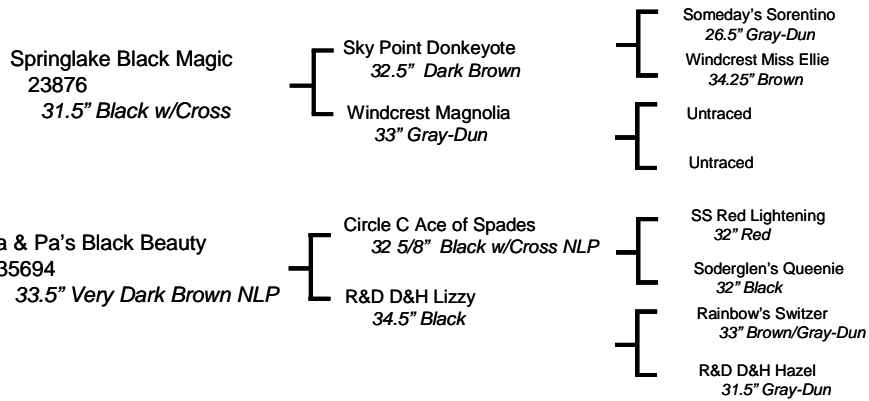

Beauty's one of our farm favorites... heavy coated in the winter... Small, quiet and very friendly, add some dark genes to your herd with her!

46

Arcadian *Margarita*

Dark Red/Brown Jennet, 5/26/07, Reg. # 52524

Consignor: Arcadian Exotics, 29" Mar 08

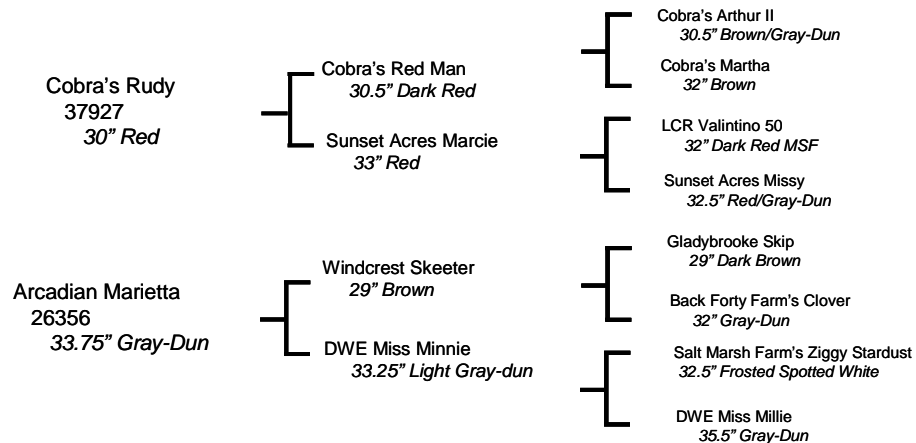

Margarita is a personable dark reddish brown jennet with tan points by Cobra's Rudy. She has a wonderful top line, and correct legs. Her full sister, Lucille, sold at last year's sale. One grandsire is Skeeter, by Skip, both 29". The other grandsire is Cobra's Red Man 30.5".

47

Big River *Destiny*

Light Red/Brown/White Spotted Jennet, 4/25/07, Reg. # 49662

Consignor: Big River Miniature Donkey Farm, 21.25" at Birth

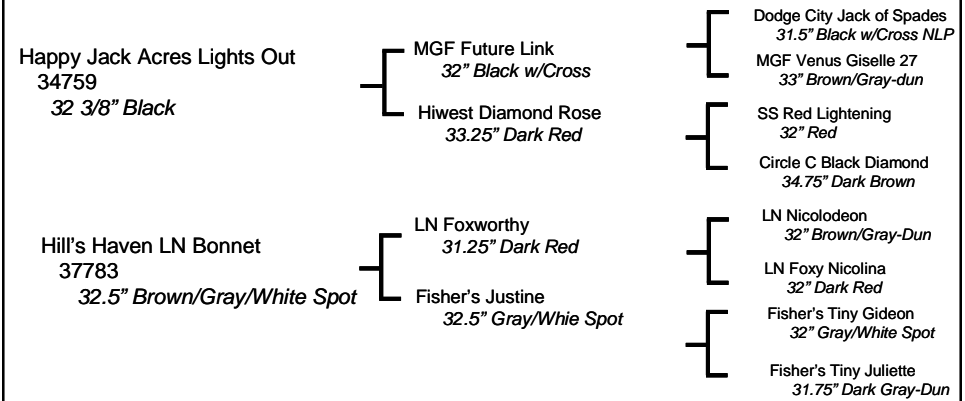

This eye catching spotted jennet has a well proportioned body, pedigree, size and color that says it all. Check out her white and sorrel color with that unusual black spot on her hip. Destiny is a grand daughter of Foxworthy and Fisher's Justine (spotted). Quite the head turner. Add this quality spotted jennet to your show string or breeding program today.

48

MGF *Over The Rainbow 797*

Brown Woolly Jennet, 10/25/07, Reg. # 52748

Consignor: McRoberts Game Ranch, 24" Mar 08

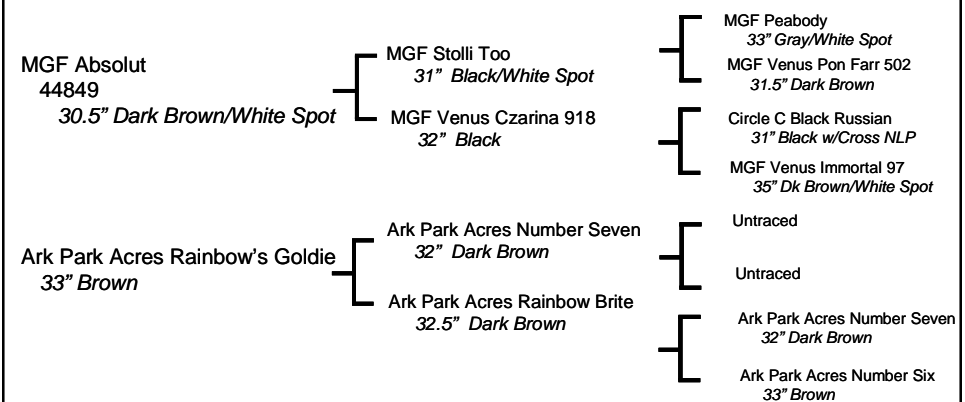

This super tiny jennet only measured 24" in March. By our amazing new herd sire - MGF Absolut and APA Rainbow's Goldie - she has inherited the woolly genes from both parents that make this little gray brown girl so special. Guaranteed, you will find a treasure, Over the Rainbow!!

49

B.J. Snow White Princess Grace

Brown/Gray and White Spotted Jennet, 7/23/07, Reg. # 51984

Consignor: Gold Mine Farm, 20.5" at Birth

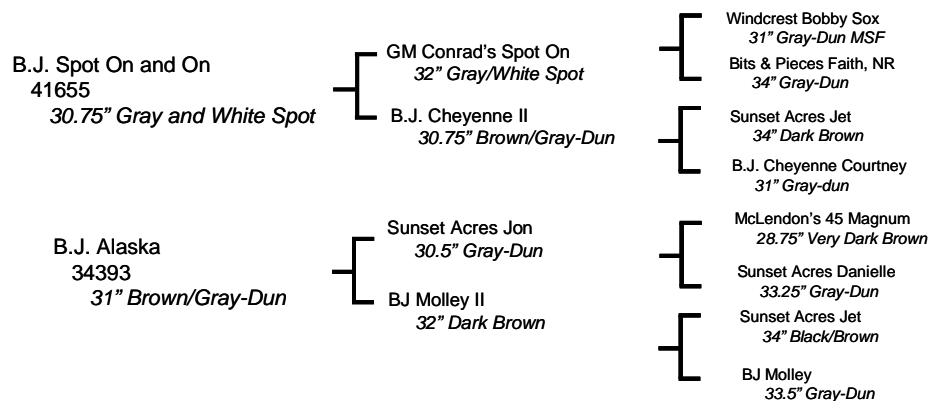

This is probably the best little donkey I have ever brought to the Great American Miniature Donkey Sale. She has great conformation, good teeth, and personality. She is easy to work with and loves attention, Her sire, BJ Spot On and On, is only 30.75" and has her same personality. The spots around both of her eyes certainly grab your interest.

50

Perfection's Junebug

Dark Brown/Gray-dun NLP Jennet, 6/26/07, Reg. # Pending

Consignor: Perfection Miniature Donkeys, Owned by Dakota Townsend

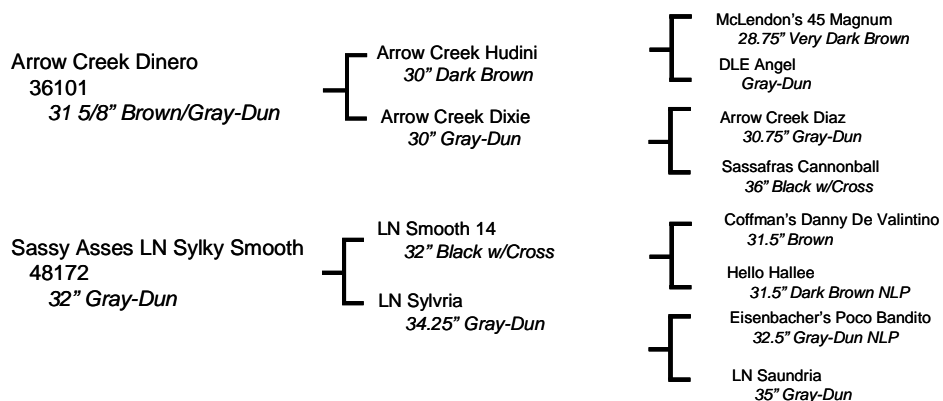

Spoiled with love, Dakota once again brings a very special grueella girl. She is as sweet as a Junebug and strives to please.

51

The Elms Black Satin

Black Jennet, 9/10/04, 33" Reg. # 40222

Maxwell Ridge Black Beauty

Black Jennet Foal, 5/1/08, 20" at Birth, Reg. # Pending

Consignor: Maxwell Ridge Farm

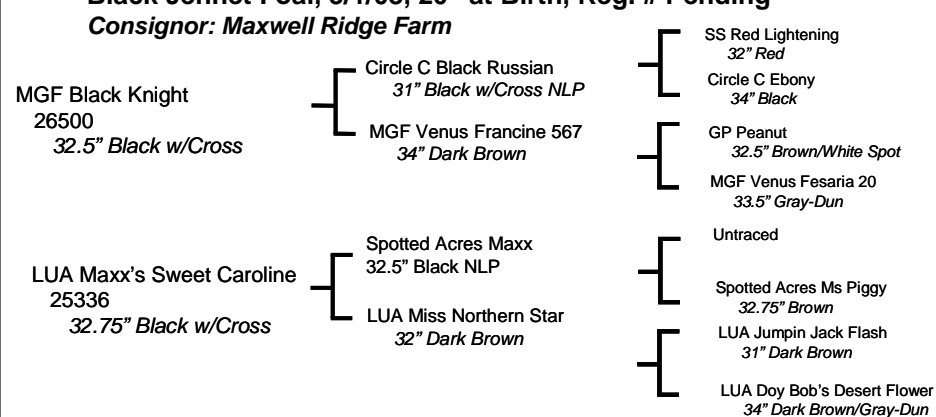

What a package! Black Satin is a beautiful true black jennet with excellent conformation and a great personality. She has a black jennet foal at side sired by 32" Country Music's Aaron Neville (Black, sired by Country Music's George Jones, out of Country Music's Kelsi Osborn). You get great genetics, great color, two great girls.

52

Long Run My Girl

Gray and White Spotted Jennet, 5/14/06, Reg. # 46600

Consignor: Long Run Farm, 32.5" May 08

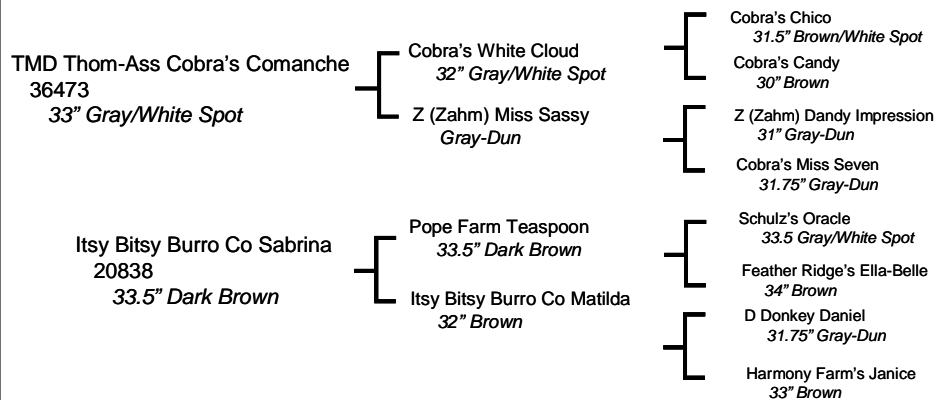

My Girl is a 50/50 gray and white spot. She is very well balanced and very refined. Nice feminine head and correct legs and bite. Her grand sire is the great show jack, Teaspoon, who was Grand Champion at Houston. Her sire is Comanche, now a driving donkey earning points for Versatility Hall of Fame and NMDA Ambassador of the Breed.

53

The Elms *Kira Kanawha*

Brown/Gray-Dun Jennet, 9/24/07, Reg. # 51997

Consignor: Elms Farm Miniature Donkeys, 20.25" at Birth

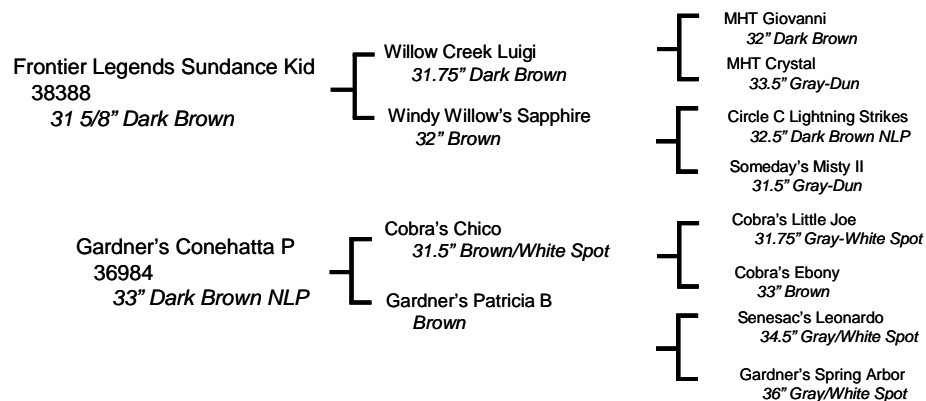

Kira's sire is a small and very stocky multiple show Champion. Her dam is an elegant, correct and feminine grulla jennet. Kira is staying small, has a winning personality, and looks to combine the best of both parents! If you like small AND stocky, give her a good hard look.

54

Ass-Pirin Acres *Sasha*

Dark Brown Jennet, 5/24/06, Reg. # 48580

Consignor: Ass-pirin Acres, 31.75" Feb. 08

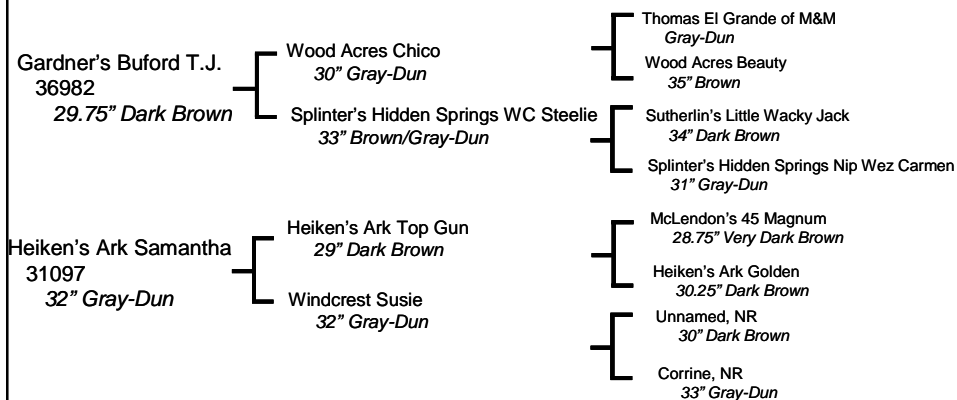

Buford T.J. never lets us down. Sasha's another small, drafty dark jennet that fits the breed standard. Between her sire and dam's pedigrees, how could she not be wonderful!

55

The Red Gate's *June-Bug*

Gray and White Spotted Jennet, 6/23/00, Reg. # 27805, 33.25"

West Ridge *Dust Bunny*

Gray and White Spotted Jennet, 5/2/08, 19.5" at Birth

Consignor: West Ridge Acres

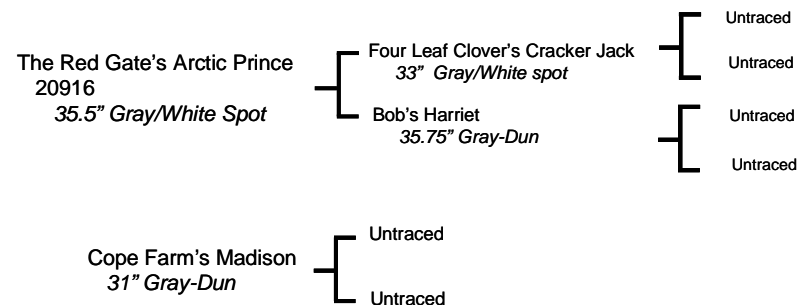

June-Bug took 2nd in 3 Year old Halter Jennets at Ohio State Fair, 3rd in Halter at the '04 Bedford Co. Fair. With straight legs and a nice round rear end, she is friendly and easy to handle. She had a spot jennet in '06, and she has a spot jennet by our sire, HHAA Riff Raff. (Red/Brown by PGF Peppercorn Jack, out of Windcrest Copper Penny). Riff placed 3rd in Foals to Halter at the '03 Great Mule and Donkey Show, and 6th in '04. June-Bug sells ready to breed.

56

Bainbridge's *Strawberry Pie*

Dark Red Jennet, 4/23/06, Reg. # 47950

Consignor: Bainbridge's Long Ears Acres, 32" Mar 08

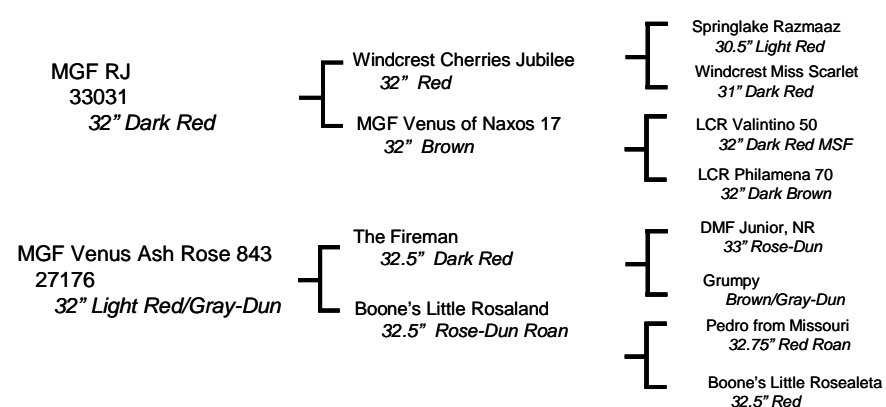

Talk about a TANK of a donkey. Strawberry Pie has a conformation that is second to none - thick, thick, thick. She is a deep, dark red and has a great pedigree to boot. Anyone would be proud to own this one!

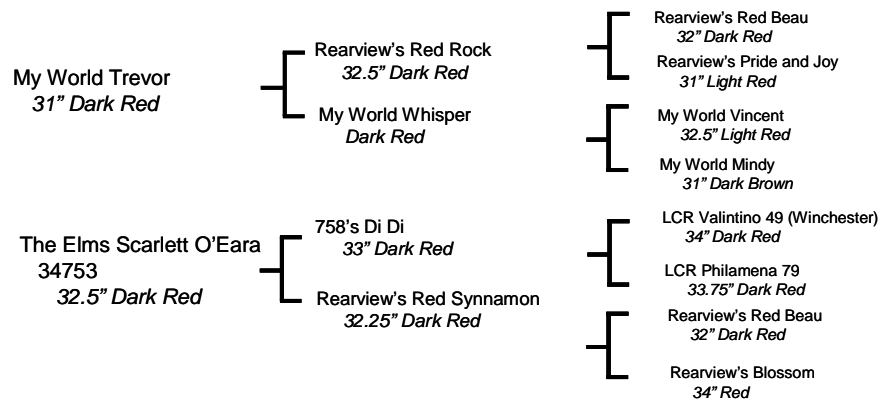
57**RBM *Curly Sue*****Dark Red Jennet, 8/21/06, Reg. # Pending****Consignor: Red Barn Miniatures, 20" at Birth**

Curly Sue sports a beautiful curly red coat, just like her dam's. When looking for red, what could be better than an Elms Farm and My World jennet!

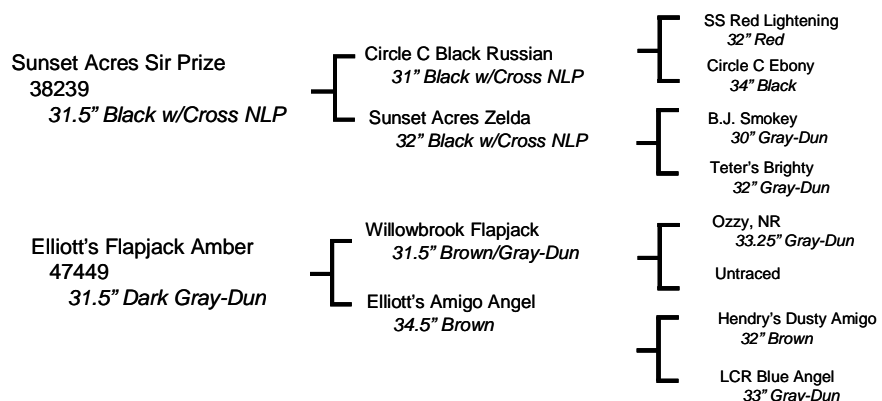
58**Hill's Haven *Midgey*****Dark Gray-Dun Jennet, 8/14/07, Reg. # 52234****Consignor: Hill's Haven, 17.5" at Birth**

Midgey is staying very small. She's gray with red and light brown highlights. She has a great Canadian background on both sides going back to Black Russian and Red Lightening. Her Grand Dam was one of the first brood jennets used in Canada. She's very correct and stocky for being so short.

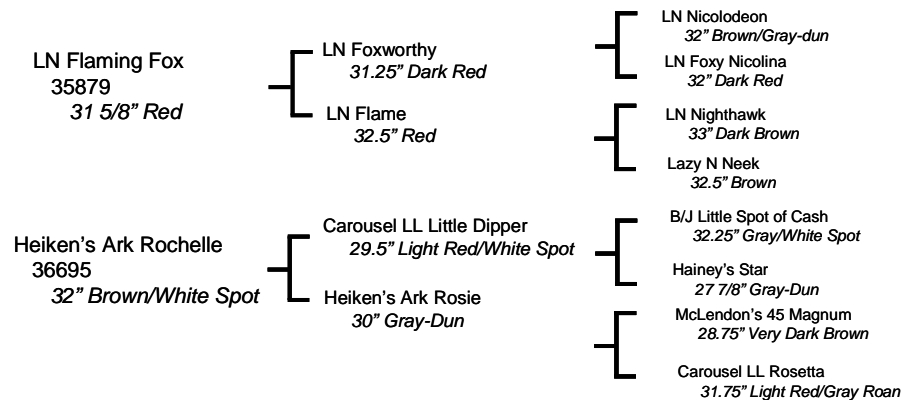
59**Heiken's Ark *Roma F*****Dark Red/Brown Jennet with Star, 5/26/07, Reg. # 52816****Consignor: Heiken's Ark, 21.25" at Birth**

Here's a beautiful dark red/brown yearling jennet who was only 21.25" at birth. She comes from a beautiful red son of Foxworthy and a very nice brown and white spotted granddaughter of Magnum. She has size, pedigree and personality going for her, and the star on her forehead is just a bonus to catch your eye. Don't pass her up.

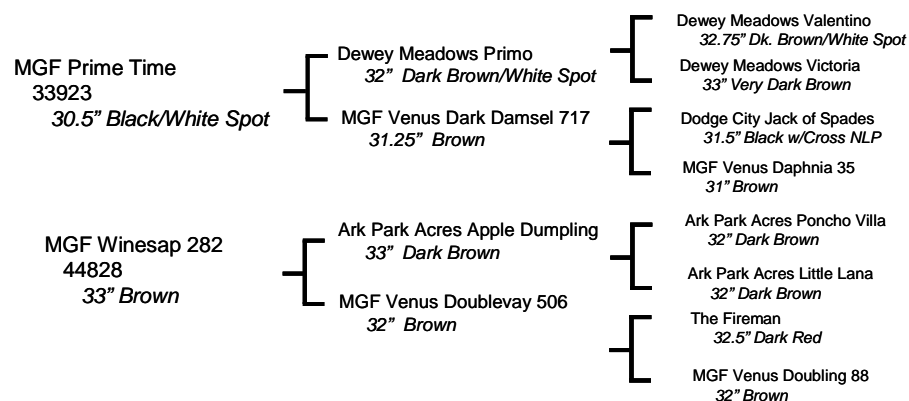
60**MGF *Twilight Time 628*****Black Jennet, 6/1/06, Reg. # 52756****Consignor: McRoberts Game Ranch, <33" Mar 08**

This true black daughter of MGF Prime Time is really correct and typy. Her mother is MGF Winesap who carries woolly genes from the APA line. With her genetics, Twilight Time will be the perfect compliment to your breeding program.

61

Daddy's Pixie

Gray-Dun Jennet, 2/21/07, Reg. # 52465

Consignor: Daddy's Darlin' Donkeys, 18.5" at Birth

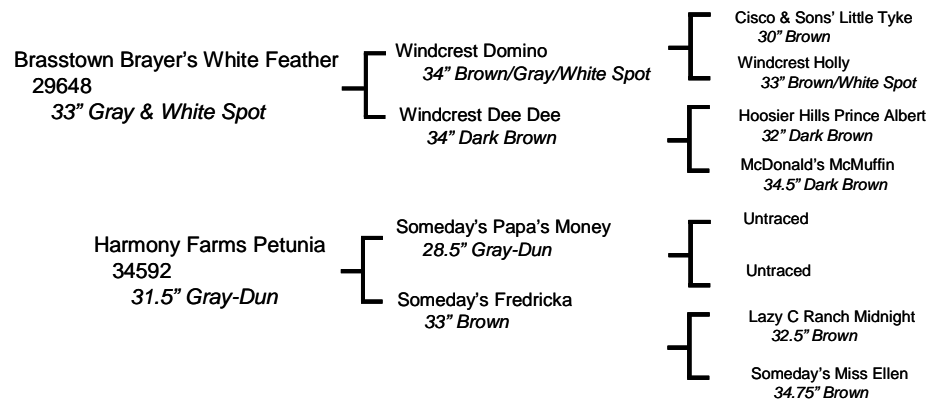

A very nice, small jenny to take home. She was 28.25" at 1 year. Pedigree includes Windcrest Copper Nugget, Someday's Papa's Money, and Lazy C Ranch Midnight. Her personality matches her pretty little face.

62

Perfection's Candyland

Dark Brown/Gray-Dun NLP Jennet, 6/10/07, Reg. # Pending

Consignor: Perfection Miniature Donkeys, 18" at Birth

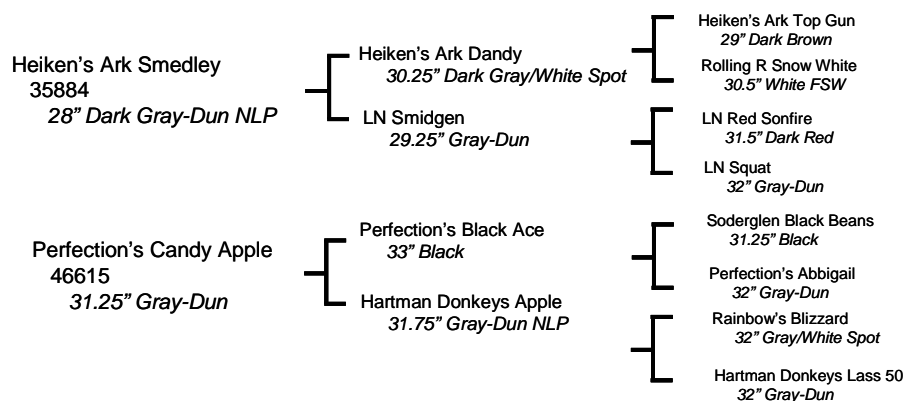

Here's the one we have been waiting for. Our first Smedley foal and a gorgeous guella with a star to boot! Small in stature with a pedigree that is both rich in color and tracing back to the original imports. Candyland is destined to headline a truly great guella breeding program.

63

Merry-Go-Round's Glory Beezz

Dark Brown Jennet, 7/20/06, Reg. # 49028

Consignor: Merry-Go-Rounds Minis, 31.25" March 2008

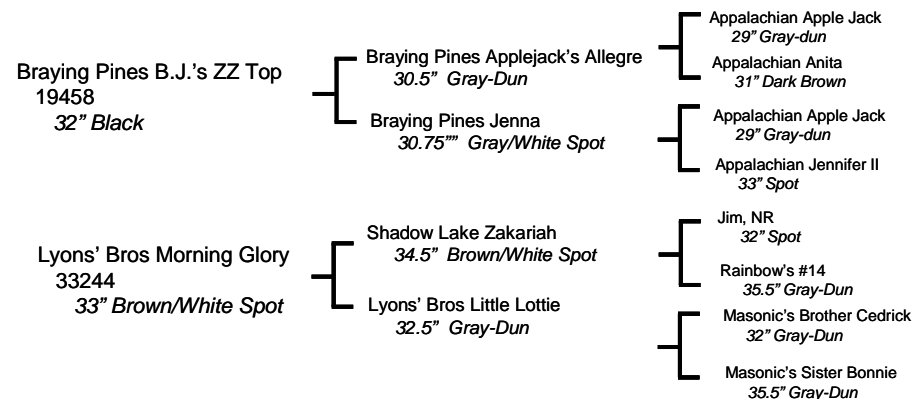

Beezz is a sweet drafty gal with nice big ears, and she is put together well. With her pedigree, filled with spots, and her black sire, consider her potential for your spot or dark breeding program. You can't miss her in the herd, just look for those ears!

64

The Elms Show Me Victory

Very Dark Brown Jennet, 6/11/07, Reg. # 50310

Consignor: Elms Farm Miniature Donkeys, 21.25" at Birth

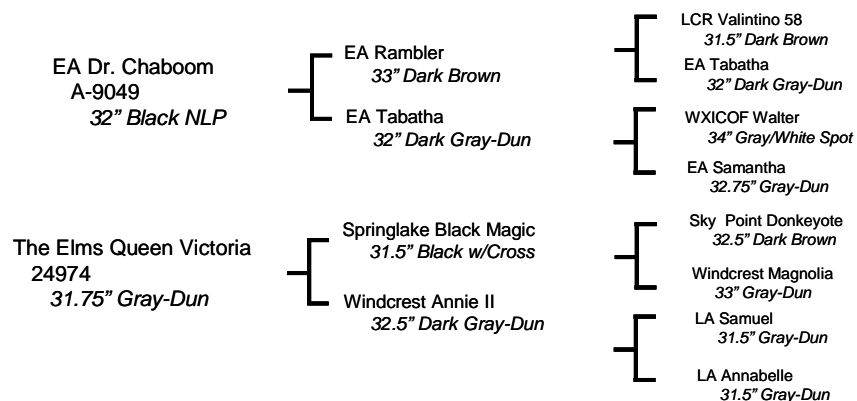

Show Me Victory - one of the best Chaboom daughters. Her mother, Queen Victoria, goes back to our original, well built, gray donkeys, and we think she crossed very well with Chaboom. Victory is stocky, willing, wide and straight! A fabulous jennet to close the sale!!

2008 Sale Donkey List

Lot #	Miniature Donkey	Lot #	Miniature Donkey
1	LER Knite-N-Gail	33	Merry-Go-Round's Miss Divina
2	Ass-pirin Acres Analiza	34	MGF Promises to Keep 652
3	Wee Ones Lots of Dots	35	TMD T-A Cobra's Comanche
4	The Elms Sedona Red	36	The Elms Sophia
5	MGF La Doncella 890	37	KC's Cutie N Red
6	Perfection's Charmin Misty	38	Ass-pirin Acres Hoshi
7	Heiken's Ark Simone LD	39	KZ Romeo's Enchanting Eve
8	Merry-Go-Round's Eye Candy	40	Perfection's Calypso
9	RBM's Bobbi Sue	41	West Prairie Tina
10	Sunset Acres Sugar Fire	42	The Elms Red Satin Doll
11	Perfection's Im In Love	43	Ass-pirin Acres Pat E Cakes
12	The Elms Little Minibrays	44	Hill Country Connie Sue
13	MGF Fyre'N Ice 780	45	Treworlas Magics Beauty
14	Designer Donkeys Autumn	46	Arcadian Margarita
15	KZ Radiance in the Mist	47	Big River Destiny
16	Daddy's Annie	48	MGF Over The Rainbow 797
17	Arcadian Michaela	49	BJ Snow White Princess Grace
18	The Elms Pipsissewa	50	Perfection's Junebug
19	Big River Esther	51	The Elms Black Satin
20	Hill's Haven Torah	52	Long Run My Girl
21	West Prairie Andrea	53	The Elms Kira Kanawha
22	Bainbridge's Poppy's Petal	54	Ass-pirin Acres Sasha
23	BJ Oprah Girl	55	The Red Gate's June Bug
24	Wulff's Rita Little Maria	56	Bainbridge's Strawberry Pie
25	Suncreek Penny	57	RBM Curly Sue
26	MGF Lady Baccarat 799	58	Hill's Haven Midgey
27	Stoney Acres Katerina	59	Heiken's Ark Roma F
28	Perfection's Misty Morning	60	MGF Twilight Time
29	KC's Flicker's Fancy Lady	61	Daddy's Pixie
30	Treworlas Tiffany's Gold	62	Perfection's Candyland
31	Heiken's Ark Kierra T	63	Merry-Go-Round's Glory Beezz
32	Assphalt Acres BJ 55	64	The Elms Show Me Victory

See WWW.DONKEYS.NET for Pictures

2009 Great American Miniature Donkey Sale
Sale Day – Saturday, August 1, 2009

Now is the time to select those special donkeys you will want to represent your farm breeding program in the 2009 Sale. Sale planning begins in December, deadline in February. Contact us anytime to discuss potential entries and details.