



Saturday July 29, 2006
Historic Lebanon, Ohio - Fairgrounds

.....
***Select Miniature Donkeys from Breeders
Across North America***

.....
***Quality Conformation, Diverse Pedigrees, All Colors,
Jennets - Yearlings, 2 year olds, Mature, Bred and With Foal
Also A Driving Gelding With Cart & Harness***

.....
**Visit WWW.DONKEYS.NET for
Web Catalog with pictures**

.....
Sale Sponsors
Elms Farm Miniature Donkeys
Martha & Dowell Howard
5600 Bethany Rd
Mason, Ohio 45040
donkeys@donkeys.net

Welcome To
The Great American Miniature Donkey Sale
Historic Lebanon, Ohio
At the Warren County Fairgrounds

May, 2006

Dear Donkey Enthusiast,

We are pleased to invite you to The Great American Miniature Donkey Sale, a select sale featuring quality registered miniature donkeys. The Sale will take place on Saturday, July 29, 2006 at 12:30 PM, at the Warren County Fairgrounds, next to the Lebanon Raceway, in Building C, in Lebanon, Ohio. We hope you plan to attend.

The Sale will consist of 70 miniature donkey lots. These miniature donkeys have been selected from those offered for consideration. Top breeders are consigning their best, as these donkeys publicly represent their farm and breeding program. It would literally take you many days, and thousands of miles, to view an assortment of available, quality stock like you will see represented at the Sale.

The selected miniature donkeys represent diverse bloodlines, great conformation, and a variety of sizes, colors & ages to attract breeders, show people, and donkey & equine lovers everywhere. Full information on each, including pictures (as consignors make them available), may be found on our web page, www.donkeys.net.

There is something for everyone here, whether you are an experienced breeder, or just getting started. Jennets include; yearlings, coming 2 year olds, mature jennets, bred jennets, and jennets with foals on the side. A trained driving gelding with cart & harness is also being offered. Donkey tack and gifts will be available. A silent auction with interesting and unique donkey items will raise money for the National Miniature Donkey Association (NMDA) Donkey Research Fund. Whether you are looking for a single jennet, a jennet & foal, brood jennets for your breeding program, or a loving pet, you are assured of finding only quality miniature donkeys at this sale.

This Donkey Sale is more than just an auction ; it is an event, a 'happening'. Donkey enthusiasts everywhere look forward to events such as this and we expect a large turnout from across the Continent. It is an opportunity for folks, both those with years of experience, and those first exploring miniature donkeys, to get together, share experiences, learn from each other, have some fun, make new friends, renew old friendships, and, oh yes, see, bid on, and purchase some of the finest quality miniature donkeys in North America.

We hope you plan to attend this year's Great American Miniature Donkey Sale. We are confident you will enjoy it.

Thank You for Your Support
Martha & Dowell Howard

PS - If you can't attend, but want to bid on the donkeys, please contact us before July 23 to discuss phone bidding, earlier is better.
Sale Day Telephones: 513-225-1771 and 513-919-5613.

The Great American Miniature Donkey Sale

Schedule of Events

FRIDAY JULY 28, 2006 SALE SET-UP DAY

Friday is primarily a set-up and check-in day for the Sale. All donkeys must be on site by 4:00 to allow for consignor and vet check-in. There will be limited viewing during the late afternoon. Events are planned as follows:

Viewing Begins	2:30
Silent Auction Start	4:30
Consignor's Invitational Dinner	6:00
Measurement	7:00

SATURDAY JULY 29, 2006 SALE DAY

Saturday is the Sale Day. Viewing will begin at 8:00. Breakfast & lunch will be available for purchase. The proceeds of the Silent Auction of donated donkey related items will benefit NMDA Donkey Research programs. Please bring your donations to the Sale. The Donkey Sale starts at 12:30 and checkout begins shortly after the last lot is sold. Donkey tack, gifts, useful items and curios will be available.

Viewing Starts & Silent Auction Continues	8:00
Sale Vendors	9:00
Sale Starts	12:30
Payment, Vet Papers	Shortly after last lot is sold
Silent Auction ends	15 minutes after the Sale
All Donkeys Gone	before 8:00 PM

SUNDAY JULY 30, 2006 ELMS FARM OPENHOUSE

We would like to invite everyone to The Elms Farm Open House Sunday after the Sale from 8:30 until? We're close to Lebanon and are between I-75 and I-71 for easy access. Directions: Turn right leaving the fairgrounds, go straight thru town, and bear right onto Rt 42. Go about 6 miles. After you pass the Kirkwood Inn, turn right on Bethany Rd., go 1.9 miles to The Elms Farm. Stop by and see our herd, have some refreshments, and talk donkey. We are looking forward to seeing you.

SALE LOCATION & DIRECTIONS

The Sale will be held at the Warren County Fairgrounds, Bldg C, adjacent to Lebanon Raceway located on Route 48, 0.7 miles north of the town center of Lebanon, OH. You enter through Gate 4. The Lebanon Raceway, a private company, will be in operation, so no parking on paved areas. Parking for the Sale will be indicated.

From I-75, take exit #29 (Monroe, Lebanon, Rt 63) east to Lebanon, 7 miles. Turn left on Broadway (Rt 48 North), go 0.7 miles to the Fairground.

From I-71, take exit #28 (Rt 48), turn North, go 2 miles to Rt 123, exit west toward Lebanon, go 1 mile, turn right on Broadway (Rt 48), go 0.7 miles to the Fairground

Auctioneering & Clerking

Kevin Wendt, Auctioneer
5455 Rings Rd, Suite 100
Dublin, OH 43017
614-789-1627

The Great American Miniature Donkey Sale

TERMS AND CONDITIONS

Terms: Terms of the sale are cash or good check, with photo identification. All donkeys must be paid for immediately at sale end. No animals may be removed prior to close of the sale, and all donkeys must be removed from the premises by 8 PM, unless other arrangements have been made with the sponsors. (We can help you if you want to attend / phone bid, but won't have a trailer at the Sale. Call us.)

Bidding: All donkeys sell to the highest bidder. Any disputes or challenges will be settled by the auctioneer, and his decision will be final. The auctioneer may reject any or all bids. Bids are per lot. Jennets with foals on the side sell as one lot.

Risk: The owner assumes all risk for the donkey up to the point of sale. The buyer assumes all risk at the moment the auctioneer declares the animal is sold. The management is not responsible for loss or damages to personal property.

Announcements: All announcements on sale day from the auction block will take precedence over the material printed in this catalog. Every effort has been made to ensure the accuracy of the catalog. However, we assume no liability for errors or omissions.

Contract: The management, auctioneers, and employees act as agents for the seller, but assume no liability for either the buyer or the seller. Any representations made by the sales management are made on behalf of the seller.

The above terms and conditions shall constitute a contract between the buyer and the seller of each animal sold. All guarantees are between buyer and seller.

Health: The EIA/Coggins test will be less than 6 months old. Current health papers for transportation with state stamp should be good for 7 days past sale date. Proof of pregnancy from a veterinarian is required for bred jennets, otherwise sold as exposed. **Buyers are responsible to obtain the paperwork they need from the veterinarian after payment immediately following the Sale.**

Transport: We may be able to help you get your donkey(s) home. Please let us know if you may need this assistance.

Export – The buyer will assume all costs incurred for additional veterinary work, quarantine, shipping, and any necessary expenses. For further clarification, please contact us – we export frequently.

General: Please note that donkey heights in the catalog have been provided by the seller. These may be adult or immature heights and are included only as helpful data. We encourage you to measure donkeys you are interested in purchasing, if the data provided seems inaccurate via visual inspection. All donkeys will be measured in public view at a designated area after arrival at the fairgrounds.

Absentee/ Phone Bids

Please contact Dowell or Martha Howard at 513-398-3341 by July 23 for details.

Please Bring This Catalog – Supplies Are Limited

The Great American Miniature Donkey Sale

Camping & Lodging

Camping: Camping is available Friday night at the Fairgrounds for \$10. Water & electric hook-ups, dump station, restrooms & HOT showers. 250 ft from the Sale.

Historical Lodging: The Golden Lamb, 27 S. Broadway, Lebanon, OH 45036, 513-932-5065, goldenlamb.com, Ohio's oldest Inn, 200 years of US history. 8 Presidents, Mark Twain & Charles Dickens stayed here, 1 mile to the Sale

Bed & Breakfast: The Hatfield Inn, 2563 Hatfield Rd, Lebanon, OH 45036, 513-932-3193 or 888-247-9793, www.bbonline.com/oh/hatfield/, 1810 renovated home on 55 Ac farm, large rooms., about 5 miles to Sale. Nice, breakfast

Motels – Just a selection, many more listed on the web site – www.donkeys.net
● Indicates where people have told us they enjoyed staying in the past

Lebanon (I-71 Exit # 28 or I-75 Exit # 29)

● **Shaker Inn**, 600 Cincinnati Ave (on Rt 42), Lebanon, OH 45036, 513-932-7575, 800-752-6151, www.shakerinnmotel.com, about 1 mile from the Sale

I-71 Exit # 25

● **Kirkwood Inn**, 4030 S US Rt. 42, Mason, OH 45040, 513-398-7277, 800-732-4741, www.kirkwoodinn.com, (across from the Houston restaurant – reasonable priced American food – good), about 6 miles from the Sale

Super 8 Motel, 5589 Kings Mills Rd, Mason, OH 45040, 513-398-8075, 800-800-8000, www.super8.com, about 8 miles from the Sale

I-75 Exit # 29

● **Super 8 Motel**, 150 New Garver Rd, Monroe, OH 45050, 513-539-2660, 800-800-8000, www.super8.com, about 8 miles from the Sale

Days Inn, 120 Senate Drive, Monroe, OH 45050 513-539-2660, 800-329-7466, www.daysinn.com, about 8 miles from the Sale

Hampton Inn, 40 New Garver Rd., Monroe, OH 45040, 513-539-4400, 800-hampton, www.hamptoninn.com, about 8 miles from the Sale

Elms Farm Miniature Donkeys

We strive to produce quality miniature donkeys with excellent conformation, great dispositions and personalities

- * **Correct, drafty donkeys, with emphasis on sorrels, blacks, & darks.**
- * **Large sorrel herd, one of the most genetically diverse anywhere.**
- * **5 Herd Sires - 3 Sorrels, 2 Blacks**
- * **Every foal carries sorrel or black genes or both.**
- * **Breed stock selected from herds across North America**
- * **Each mating planned to strengthen desirable characteristics.**
- * **Foundation Herd Planning – Export Expertise – Carts & Harness**
- * **'Shipping Around the Corner or Around the World' SM**

2006 Consignor List

Big River Miniature Donkey Farm, Jeff & Brenda Runge & Sons
2236 M-A-M Trail, Monmouth, IL 61462, 309-734-6728, bjrunge@maplecity.com, www.bigriverdonkeys.com, **Lots 12, 68**

Bray'n Pool, Lester & Linda Sutherland, 6821 Alber Rd., Saline, MI 48176
734-834-4597, donk@braynpool.com, www.braynpool.com, **Lot 30**

Double V Farm, Julie Branden & Bruce Varney, 8605 Kemman Rd., Hebron, IL 60034, 815-648-9075, doublevfarm@hughes.net, www.dblvfarm.com, **Lot 8**

Elms Farm Miniature Donkeys, Dowell and Martha Howard, 5600 Bethany Road, Mason, OH 45040, 513-398-3341, donkeys@donkeys.net www.donkeys.net, **Lots 3, 22, 31, 55, 70**

Feather Ridge Farm, Dennis Banning, 521 Mill Street, Williamston, MI 48895
517-655-3873, **Lots 9, 23, 52**

Frontier Legends Miniature Donkeys, Koby & Charla Schooler, Skip & Patsy Oertli, PO Box 925, Bertram, TX 78605, 512-355-2180, donkeys@frontierlegendsminidonk.com, www.frontierlegendsminidonk.com, **Lots 19, 49**

Gold Mine Farm, Barb & Jerry Persinger, 21 Kuester Lake, Grand Island, NE 68801, 308-380-0623, persinger4@aol.com, **Lots 24, 65**

Golden's Point, Larry & Jill Golden, Rt 2, Lockney, TX 97241, 806-652-3196
Jllgolden@aol.com, **Lots 6, 39, 56**

Great Asspectations Farm, Laura & Gil Kostyn, 1138 Township Rd. 346, Nova, OH 44859, 419-652-3642, Lauraandgil@aol.com, www.greatasspectations.com, **Lot 32**

Gusty J Ranch, Jay & Sandy Johnson, 94 W. Johnson Rd., Wheatland, WY 82201, 307-322-5871, bailey1@aci.k12.wy.us, **Lots 25, 61**

Half Ass Acres, Joe & Dayle Haworth, 2359 Feed Mill Rd., Chapel Hill, TN 37034, 931-364-3715, minidonks@united.net, www.minidonks.com, **Lots 5, 40, 50**

Heiken's Ark, Dick & Kathy Heiken, PO Box 35456, Des Moines, IA 50315
515-962-0667, heikensark@aol.com, www.heikensarkexotics.com
Lots 15, 33, 47, 57

Hill's Haven, Bill & Sue Hill, 3305 203rd St., Fort Madison, IA 52627, 319-372-3539, hillshaven@lisco.com, www.hillshavendonkeys.com, **Lots 16, 36,**

KZ's Ass-Piration Acres, Kim & Don Zellers, 1213 Rt. 23, Wantage, NJ 07461
973-702-8067, amberz@tellurian.net, www.kzasspirationacres.com,
Lots 20, 64

2006 Consignor List

Lamb's Exotic Ranch, Paul & Edna Lamb, 1056 N. 800 E. Rd., Bement, IL 61813, 217-678-7241, **Lot 28**

Little Bit of Heaven, Jack and Sue Pentland, 6480 W 900 N, Royal Center, IN, 46978, 574-643-9359, jack@cqc.com, www.littlebitofheavenminidonks.com
Lots 17, 44, 63

Lil' Half Pint's, Doug & Sonja Campbell, PO Box 67, Eldon, MO 65026
573-392-3575, lhpints@usmo.com, home.usmo.com/~lhpints,
Lots 7, 38, 62

Long Run Farm, Betty & K.C. Stegemoller, 3500 Utica Rd., Lebanon, OH 45036, 513-932-1601, longrunminidonks@aol.com, **Lots 14, 45, 66**

Linda McHugh, 12498 Guelph Line, R.R. 1 Campbellville, Ontario, LOP 1B0 Canada, 519-856-4352, lindam.ofbunkerhill@sympatico.ca, **Lot 34**

McRoberts Game Ranch, Jerry & Barb McRoberts, PO Box 55, Gurley, NE 69141, 308-884-2371, jbmrcrob@daltontel.net, www.mcrobertsgamefarm.com
Lots 1, 11, 37, 43, 48, 67

Merry-Go-Round Minis, Marlene Clark, 14500 Van Syckle Rd., Gregory, MI 48137, 734-498-3590, grclark@hughes.net, www.merry-go-round-minis.com
Lots 10, 26, 54

Nissen's Lazy N Ranch, Jon, Mary & Jay Nissen, 1080 Hwy 17, Corwith, IA 50430, 515-824-3603, nissens@lnminidonk.com, www.lnminidonk.com
Lots 13, 60

Perfection Miniature Donkeys, Val & Deone Townsend, RR1, Site 7, Comp 14, Sylvan Lake, AB T4S 1X6, Canada, 403-887-2285, lsangus@telusplanet.net
Lots 2, 27, 42, 53, 69

The Red Gate, Scott & Theresa Ellinger, 14677 Dutch Cross Rd., Centerburg, OH 43011, 740-625-9092, theredgate@axom.com, www.theredgate.com,
Lot 21

Short & Sweet Donkey Ranch, Frank & Mary Williams, 1914 Hwy 79 E, Henderson, TX 75652, 903-657-5382, donkeyhill44@aol.com, www.shortnsweetdonkeys.com, **Lots 4, 41, 59**

Willmann West Prairie Farm, Gene & Betty Willmann, 5455 West Prairie Dr., Belleville, IL 62220, 618-235-0221, genewillmann@sbcglobal.net,
Lots 29, 51

Yorkleigh Farms, Dr. Brian & Julie Taylor, Box 341, Nanton, AB Canada TOL 1R0, 403-395-2348, jutaylor@telusplanet.net, **Lots 18, 35, 46, 58**

1 MGF *Apple Blossom* 330

Frosted Spotted White Jennet, Bred for Fall 06 or Spring 07

Consignor: McRoberts Game Ranch, 6/15/03, Reg #45741

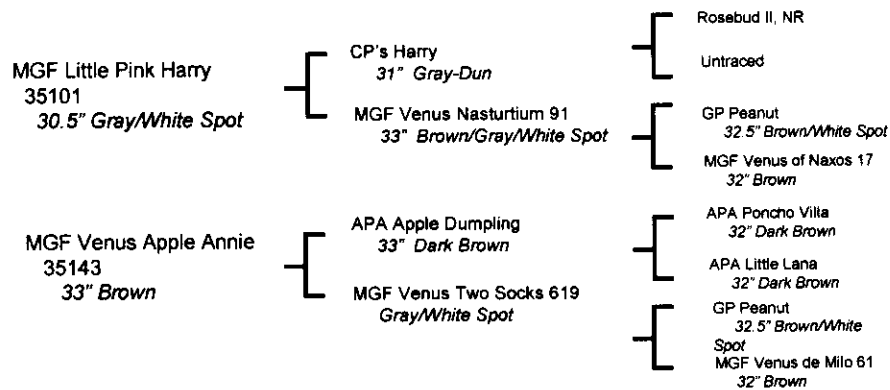

Apple Blossom, a fitting name for this beautiful, stocky, frosted sorrel with fantastic long, woolly hair. Her mother is also stocky and woolly. All that white hair makes her stand out in the field! Apple Blossom sells bred to MGF Husker Pride, a beautiful red, black & white spotted jack. You will be holding your breath to see what comes out of this pairing!

2 Perfection's *Gretchen*

Black Jennet, 9/26/05, Reg. # Pending

Consignor: Perfection Miniature Donkeys, 18.75" at Birth

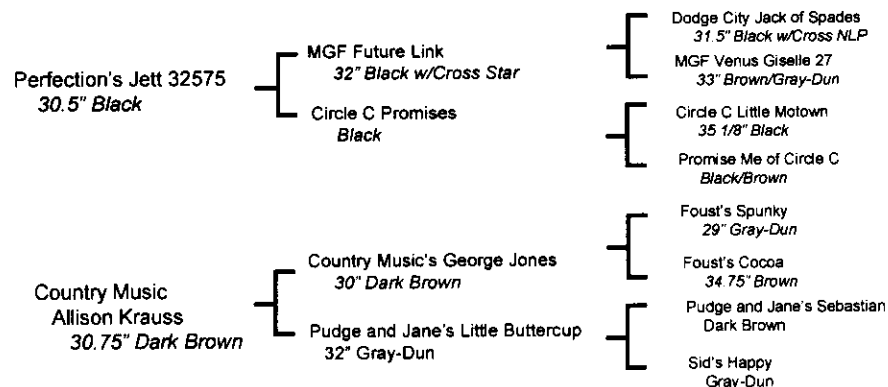

Like a little black dress, this little gem will never be out of date, or style. Gretchen has multiple World, National and NMDA Champions in her pedigree. A half sister to the 2004 World Champion Jennet, Perfection's Smartie Pants, Gretchen is destined for greatness. She will be shown at the Calgary 2006 World Miniature Donkey Show. Take this little black beauty home and show her, then watch the rewards roll in. Let Gretchen's success be your success.

3 The Elms *Rose Chiffon*

Light Red Jennet, 8/13/05, Reg. #43949

Consignor: Elms Farm Miniature Donkeys, 21.25" at Birth

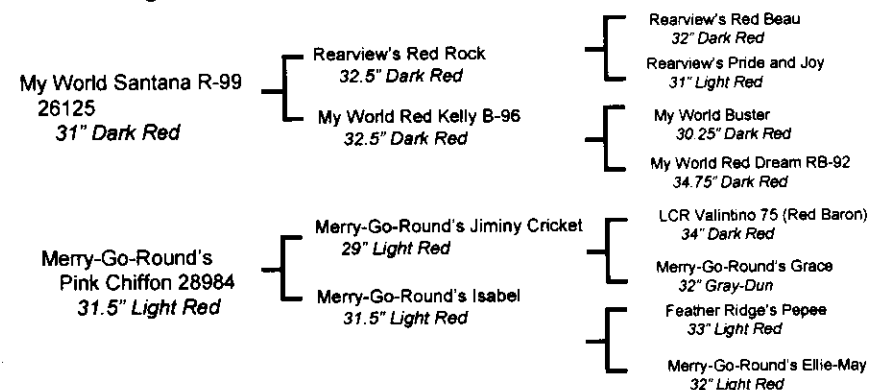

Everyone admires her mother, Pink Chiffon, as she is a striking, small, and stocky jennet, outstanding in the herd, with a glowing pink color. We paired her with Santana, for they are beautifully matched in size, build, and fluid movement. Rose Chiffon is the Santana daughter we would like to keep, but since so many have asked about a jennet foal from her dam, Pink Chiffon, we decided to offer her to you. We expect her to glow in your herd too!

4 Short & Sweet *InkaDinkaDoo*

Black NLP Jennet, 3/15/05, Reg. #42326

Consignor: Short & Sweet Donkey Ranch, 31.5" May 06

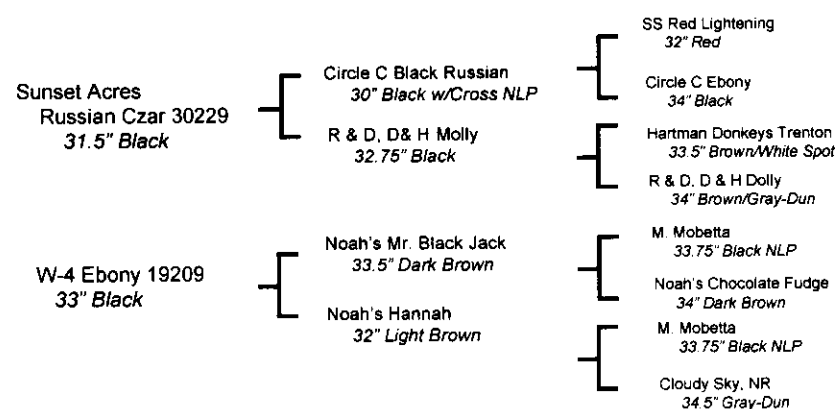

Inky- Two words describe this year old jennet: Black and Gorgeous!! She is black from the tip of her nose to the tip of her tail! If you are breeding for black, this is your girl. Strong black genetics in her background AND she's nice!!

5

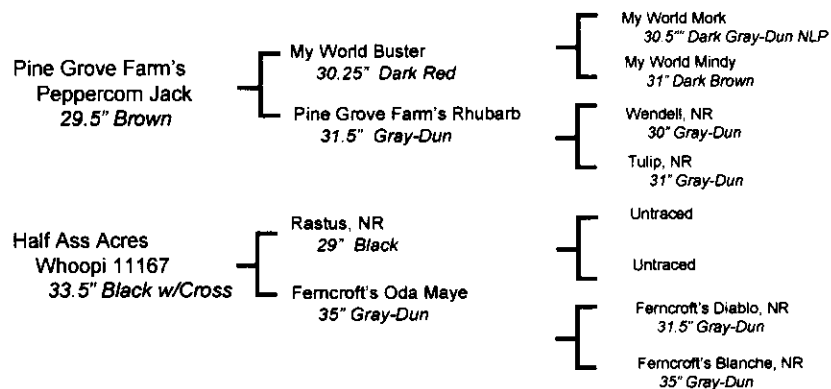
HHAA Fat Bottom Girl**Dark Brown Jennet, 4/19/05, Reg. #41982****Consignor: Half Ass Acres, 23.5" at Birth, 31.75" May 06**

'Fattie' has show quality conformation. She has one of the best rear ends I have ever seen on a baby. She also has a beautiful face with expressive eyes. Her dam and grandsire on her mother's side are black and she has "My World" bloodlines on the top. How can you go wrong with this fine girl!

6

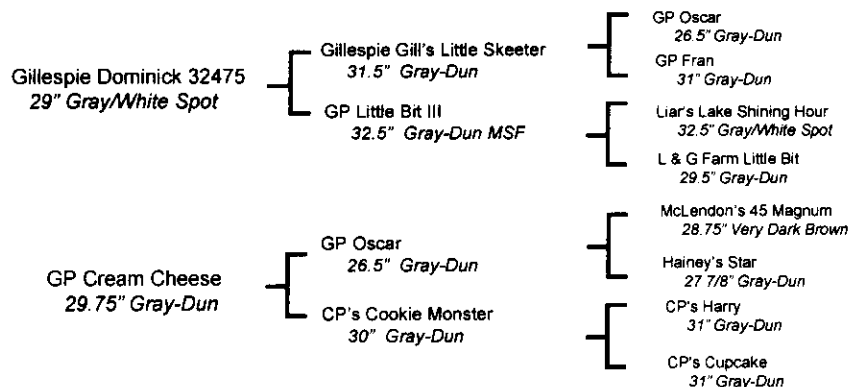
GP Nutmeg**Gray & White Spotted Jennet, 6/18/05, Reg. #43929****Consignor: Golden's Point, 18" at Birth**

Nutmeg is a very petite, spotted show ring prospect that is stacked up with the genes of the legendary 26.5" 'Oscar'. She is a small headed, straight lined, nicely balanced treasure in a small package. Congratulations to the new owner.

7

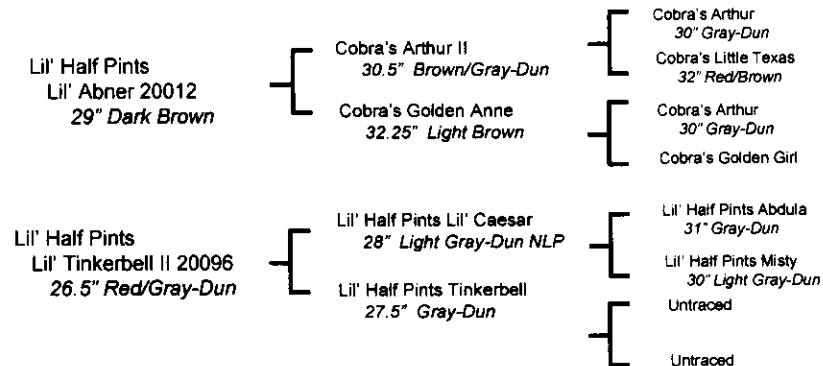
Lil' Half Pints Lil' Star**Dark Gray-Dun NLP Jennet, 5/28/05, Reg. # Pending****Consignor: Lil'Half Pints, 15.75" at Birth, 25.5" at 10 mos.**

Lil' Star is one of those jennets that will always catch your eye and your heart! She has a beautiful head with a look at me attitude, and the conformation to be competitive in the show ring, just like her show winning half brother, our black 28" Lil' Merlin. Lady Fisher of England purchased her full sister as soon as she foaled. We believe that this tiny jennet has the potential to produce black and will shine like a "star" in your show or breeding program.

8

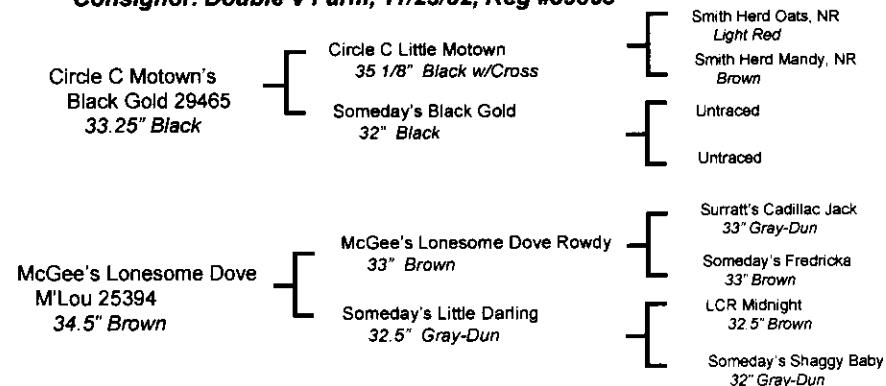
Lil' Jackson Ranch Angel**33.5" Black w/Cross Jennet, Bred for Fall 2006****Consignor: Double V Farm, 11/23/02, Reg #39363**

Are you looking for bred and black? Angel is black with a cross. Her sire, Circle C Motown's Black Gold, is a true black and has won Grand Champion Jack in National & World Shows. Angel is confirmed in foal to Circle C Hurricane, a medium sorrel, for an October foal. Hurricane won Grand Champion Jack at the 2005 Alberta Red Deer Show. He is a son of Red Lightening & Miss Houston of Circle C, and his only full brother is Circle C Legend. This is your opportunity to add 2 great Canadian bloodlines to your herd.

9

Feather Ridge's Golden Biscuit

Light Red Jennet, 7/21/05, Reg. # Pending

Consignor: Feather Ridge Farm, Height 30" Feb. 06

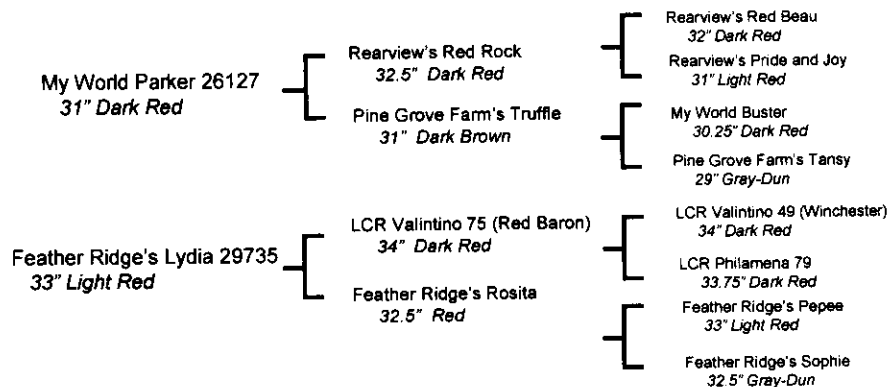

Her presence alone, along with her beautiful light sorrel color and stocky build, make her a real eye pleaser. Lots of sorrel here. With Red Baron being her grandsire, and My World Parker her sire. Her mother is my best light sorrel jenny. I've had some beautiful bright red come out of light sorrels. When she matures you'll be proud to have her.

10

Merry-Go-Round's Girlfriend

Black Jennet, 7/14/05, Reg. # Pending

Consignor: Merry-Go-Round Minis, 30.25" Feb. 06

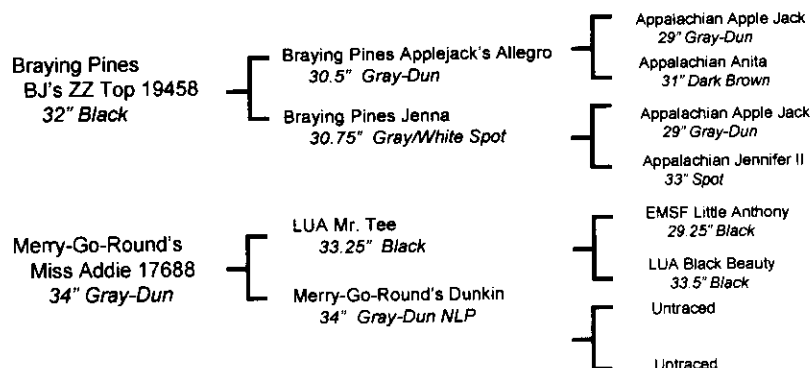

Got bone? Well Girlfriend does. Here's a premium black, drafty jennet with a good black pedigree. Her dam, Miss Addie, is a FULL sister to Mr. Perlino (cream gene). Girlfriend is one of the finest foals I've had, a treasure to any breeding program.

11

MGF Tequila Sunrise 535

Black MSF Woolly Jennet, 6/20/05, Reg. #45740

Consignor: McRoberts Game Ranch

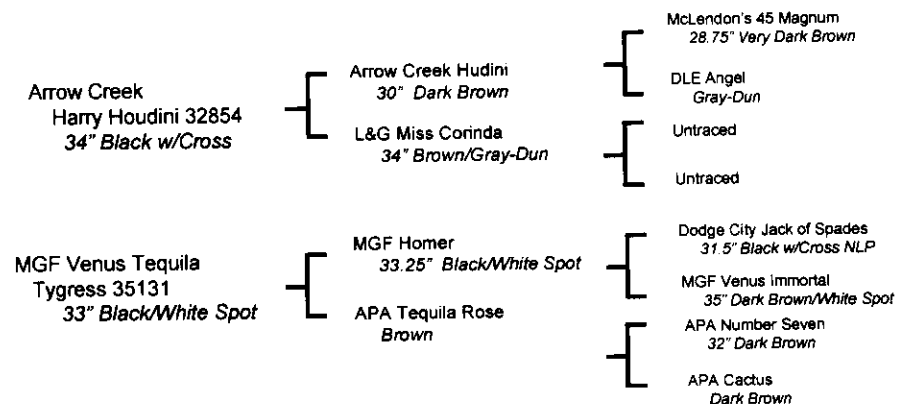

I think this long haired, super woolly, beautiful, black and white spot is comparable to last year's Ebony and Ivory. She carries herself with style, and the white accents her abundant long, silky hair. Her father is the jet black Arrow Creek Harry Houdini and her mother is a woolly black spotted Homer daughter.

12

Hill's Haven Josie

32" Brown & White Spot Jennet, 8/8/02, Reg. #43025, Bred for 2007

Big River Red Lightning

Red & White Spot Jennet Foal, 5/8/06, 21.25" at Birth, Reg. Pending

Consignor: Big River Miniature Donkey Farm

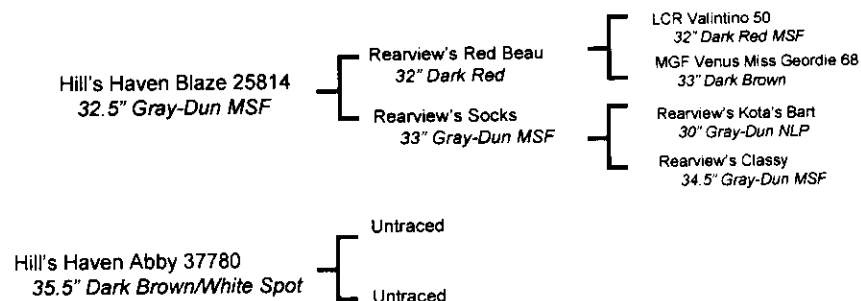

3 in 1 Family! Josie is a uniquely marked jennet that will catch one's eye. She has Valantino 50 and Rearview in her pedigree. Josie has a sorrel and white spotted jennet foal at her side, sired by Happy Jack Acres Lights Out (MGF Future Link X Hiwest Diamond Rose), a 32 3/8" true black jack. She will be exposed back to Lights Out for a 2007 foal.

13 LN *Little Foxy Vu*

Black NLP Jennet, 7/30/05, Reg. # Pending
Consignor: Lazy N Ranch, 20.5" at Birth

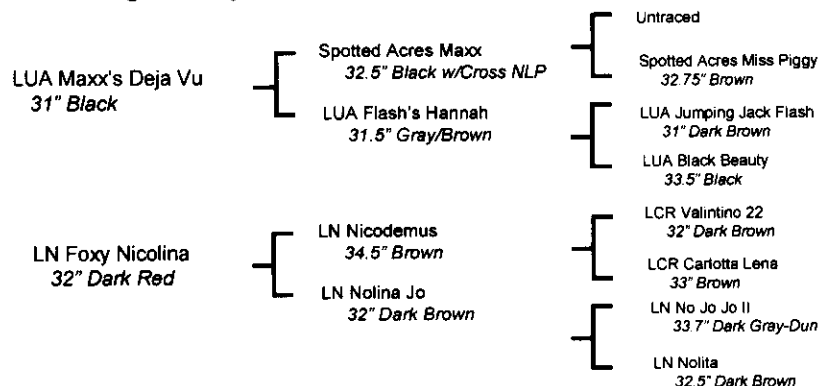

This sharp little lady is for you if you want dark with no light points, small and quality, and that is just the beginning. Both her sire and dam are very exceptional individuals - Déjà Vu by his Halter Champion winnings and great disposition and Nicolina by her great offspring, 6 have succeeded in the show ring. Not much of a gamble here, Foxy Vu already looks great, and is as sure a bet as you will find.

14 Long Run *Tuscan Sun*

Brown Jennet, 6/7/04, Reg. #43857
Consignor: Long Run Farm, Height 32.5" Mar. 06

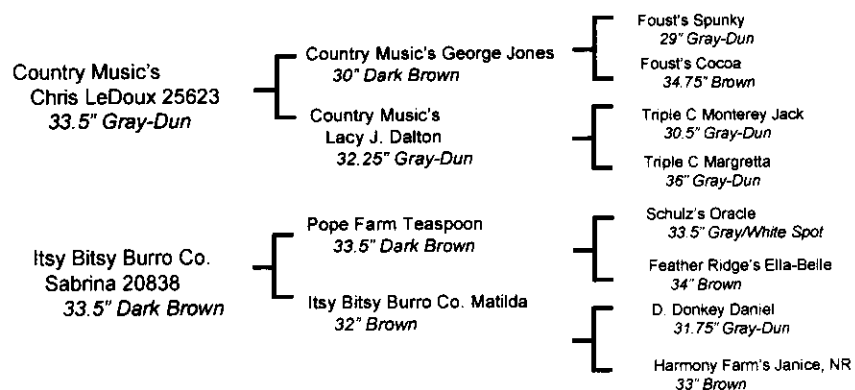

Sun is a correct, graceful, and feminine jennet. Her pedigree includes National Champions George Jones & Foust's Spunky, and the outstanding show jack, Teaspoon. Show her now, then breed her later. She is sure to be an asset to your program.

15 Heiken's Ark *Rosalie F*

Dark Red Jennet, 6/26/04, Reg. # Pending
Consignor: Heiken's Ark

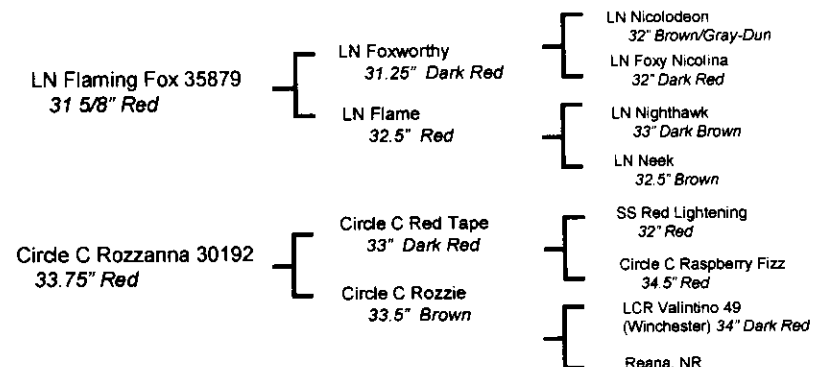

Rosalie F is a jennet whose parents are both dark red and have outstanding conformation. She is a full two years old, so closer to breeding age to the jack of your choice. Her pedigree contains many familiar names like Valintino 49 and 50, Foxworthy and Red Lightening. If you're looking for red, here is a jennet you should have

16 Hill's Haven *Koko*

Dark Brown Jennet, 5/6/04, Reg. #44801
Consignor: Hill's Haven, 21.75" at Birth

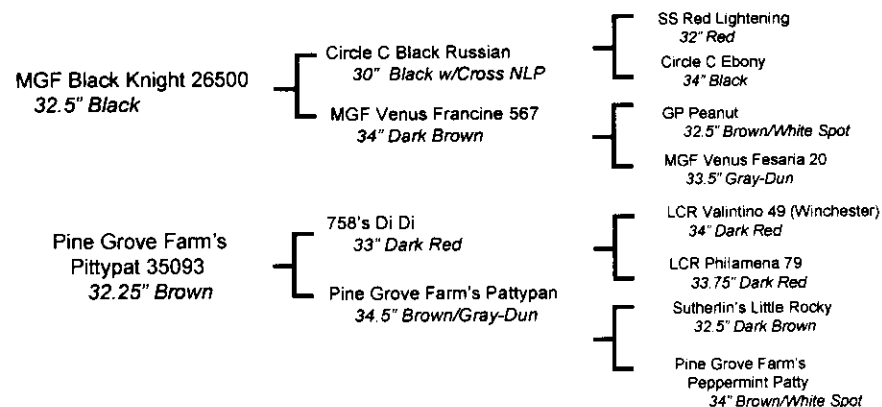

Hill's Haven Koko was 21.75" at birth. She's very lovable, great conformation, full round butt, perfect teeth, and straight legs, like her sire, Black Knight, and on back to Black Russian and Red Lightening. Her dam's side is Di Di and Winchester. Don't miss out on this girl!

17

Heavenly Poppy

Brown & White Spot Jennet, 9/14/05, Reg. # Pending
Consignor: Little Bit of Heaven, 21" at Birth

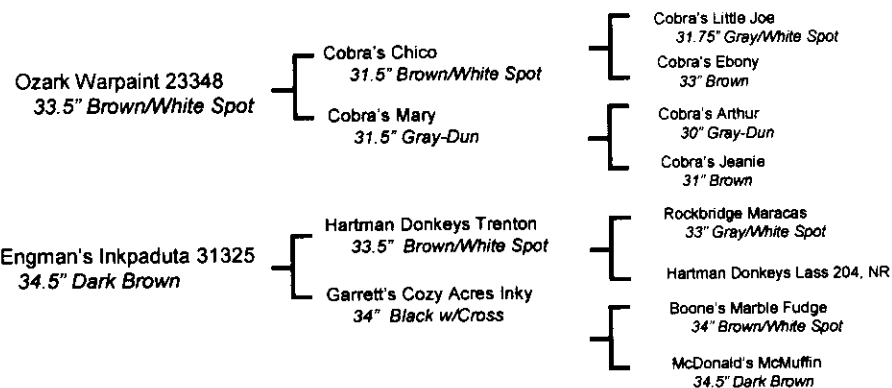

Poppy—If you are looking for spots, Poppy has spots on both sides. She would make a very nice show jennet or brood jennet. She is very sweet and easy to handle.

18

Yorkleigh Farms Orchid

Black w/Cross & Star Jennet, 9/1/03, Reg. #CDJE-4130
Consignor: Yorkleigh Farms, 30.25" Mar. 06

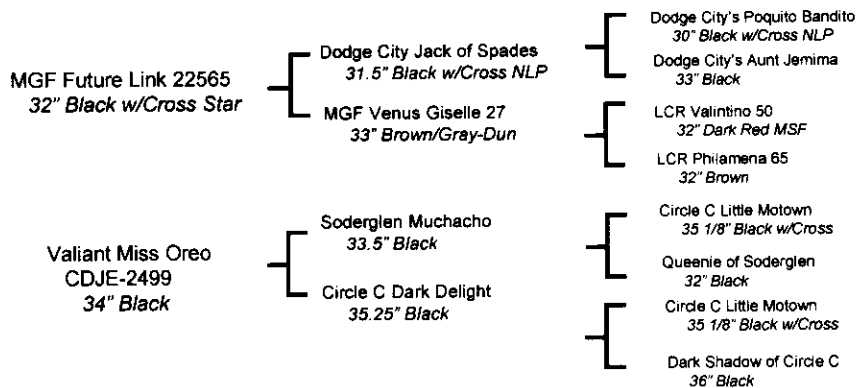

We are pleased to offer for sale this petite true black jennet. She has a small white star and gorgeous garters. Orchid has character, color and compact size. Her pedigree offers something different with her sire being Future Link, and on her dam's side the grandsire being Muchacho. Orchid will remain small, so if black genetics are what you are wanting to achieve in your breeding program, then don't miss you chance to take this flower of a donkey home.

19

Frontier Legends Bandit Queen

Dark Brown Jennet, 4/17/05, Reg. #42402
Consignor: Frontier Legends Miniature Donkeys, 22" at Birth, 30" Mar. 06

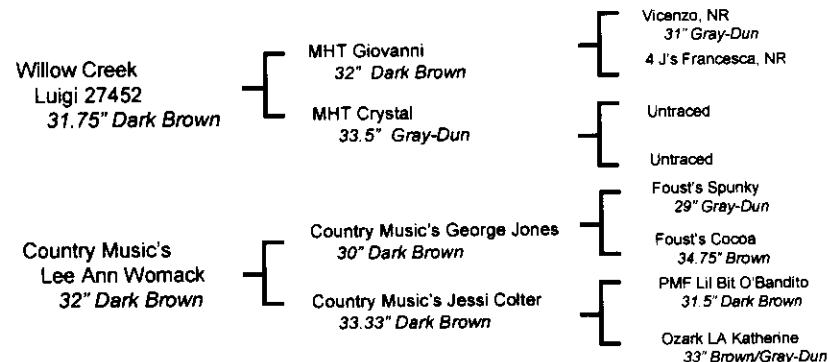

This dark brown jennet has great potential and champion bloodlines. Her sire, Willow Creek Luigi, was the 2004 ADMS National Champion. While owned by Frontier Legends, Luigi was shown 18 times and always placed, having 3 Grand Champion titles. Bandit Queen's grandsire, Country Music's George Jones, was also a National Champion. Bandit Queen placed 5th of 10 at the 2006 Texas State Championship Show in yearling jennets. This gal has the bloodlines & looks to improve and complement any breeding program.

20

KZ Mena Mime

Brown/Gray & White Spotted Jennet, 5/22/05, Reg #42872
Consignor: KZ's Ass-Piration Acres, 22.5" at Birth

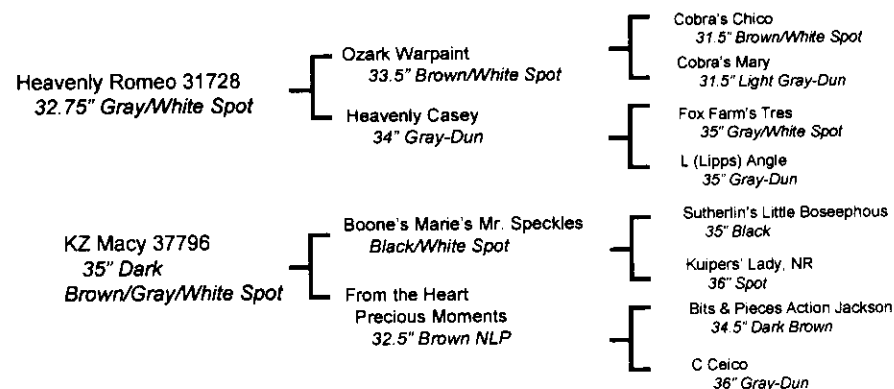

Mena is what every breeder is looking for in a spotted jenny. I almost kept her myself. She has the tyger spotting pattern. Her coloring looks just like her dam's and she has her sire's blocky, straight conformation. With black & white spotted, black, and many other spotted colors in her background, who knows what she could produce!

21

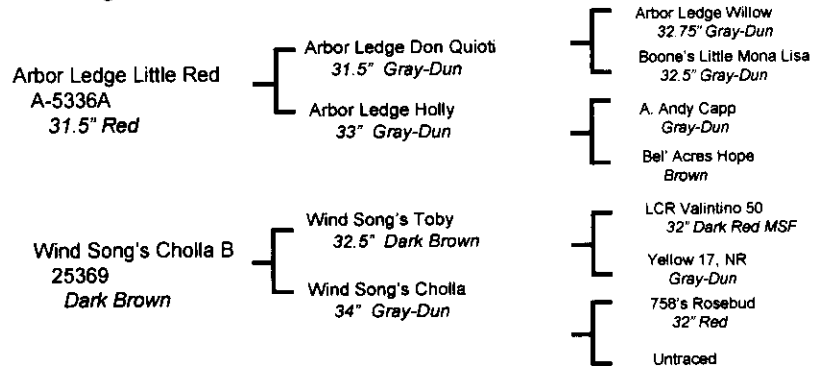
Ass-pirin Acres *Callula***32.25" Very Dark Brown Jennet, 8/18/01, Bred for 2007****Consignor: The Red Gate, Reg. #35506**

Callula is a very nice drafty, compact jennet with good bone, dark color, and a pedigree tracing to imports. She has a sweet, gentle personality and is a loving, excellent mother. Her first foal (2005), a 20.25" very stocky, very dark brown jack, is headed for the show ring. She is bred to our jack, Frontier Legends Sundance Kid, a dark brown 31.25" VERY STOCKY jack. Sundance's sire, Willow Creek Luigi is a two-time ADMS National Halter Champion and NMDA Halter Champion. Don't miss this opportunity to take Callula home with you!

22

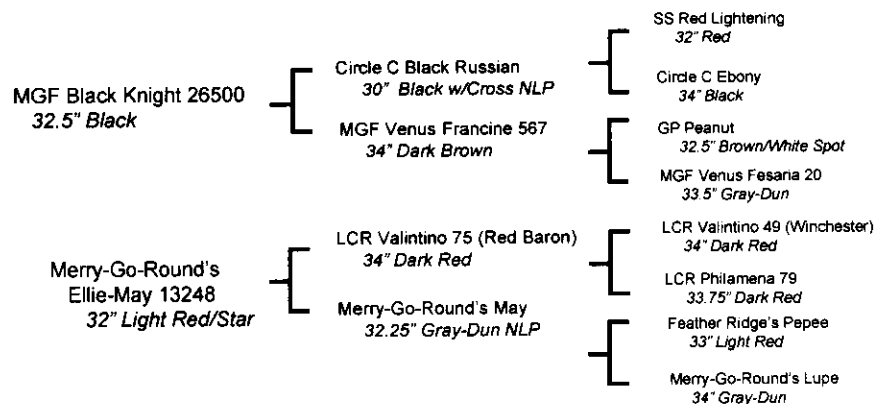
The Elms *Jaunty Splash***Dark Red Jennet, 4/12/05, Reg. #45871****Consignor: Elms Farm Miniature Donkeys, 21.75" at Birth**

Jaunty is a superb, dark sorrel jennet. She has the wide chest, straight legs, good conformation, and balance everyone wants. Her name comes from the small, off center splash of white on her forehead, not big enough to be a star, but gave her a jaunty look. She has a wonderful, willing temperament as well. We love Black Knight's foals, and this jennet is exceptional.

23

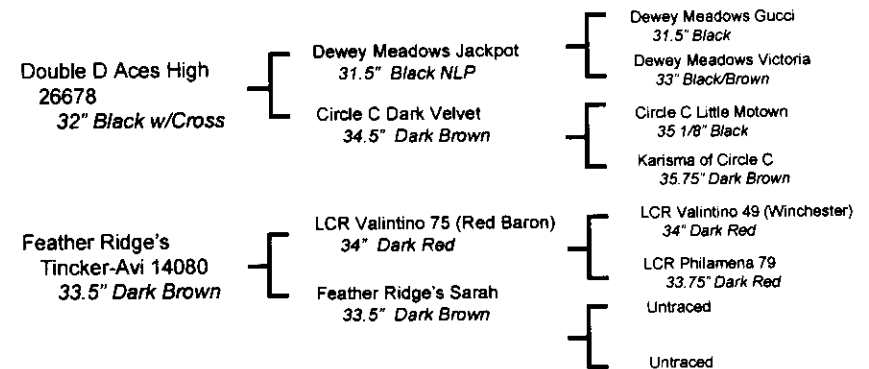
Feather Ridge's *Olga***Black w/Cross Jennet, 7/16/04, Reg. # Pending****Consignor: Feather Ridge Farm, 32" Feb. 06**

One look at this little jennet tells it all. She's the kind we all like to have in our herds. Her mother, Tincker, is one of my best dark chocolate jennys, and a Red Baron daughter. You have black and sorrel both in this little gal. I've had a lot of babies born over the years, but this one ranks up there with the best I ever produced. I think she would be a wonderful addition to anyone's donkey program.

24

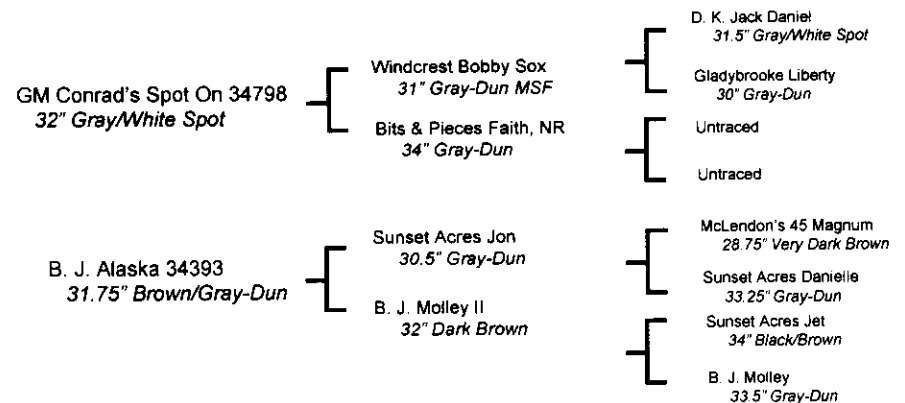
B. J. *White Princess***Frosted Spotted White Jennet, 5/15/05, Reg. # Pending****Consignor: Gold Mine Farm, 21" at Birth**

This stocky little jennet is a real jewel. Look closely to find the black patches. She is super friendly and comes with a great pedigree. She has the style we are all looking for, so check her out.

25

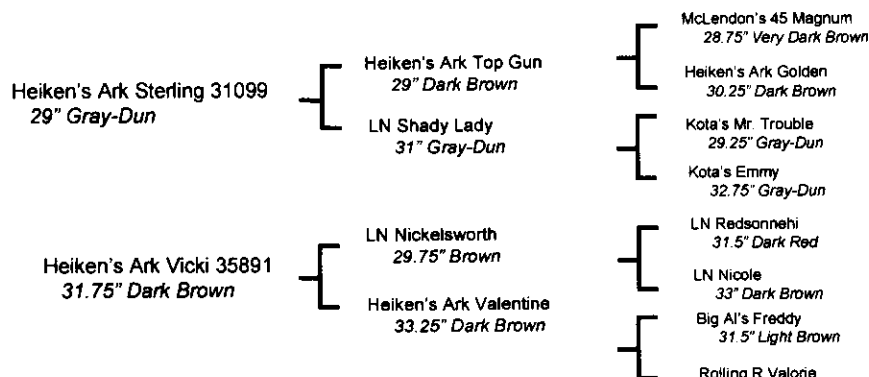
GJR Lil Glory**Brown Jennet, 7/4/05, Reg. #Pending****Consignor: Gusty J Ranch, 19" at Birth, 24" Mar. 06**

Glory is a nice, very small brown jennet born on the 4th of July. Her teeth are even and she is going to stay nice and small. Both her dam and sire are more draft style small donkeys. Glory won Grand Champion Donkey (over 23 minis, and also standards) at the Castlerock Donkey and Mule Show, Colorado, May 2006.

26

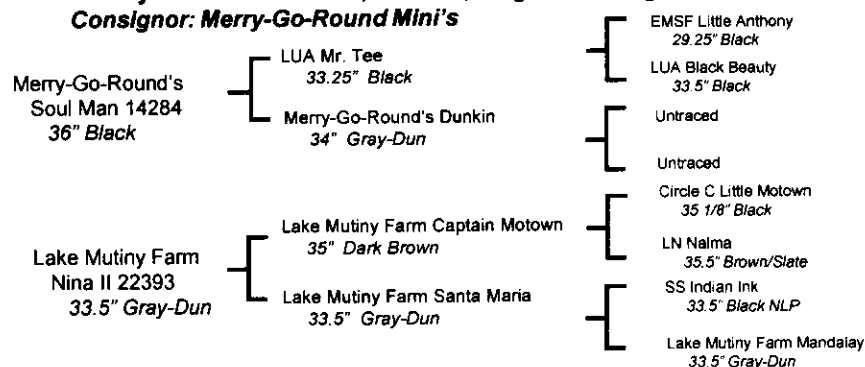
Merry-Go-Round's Soulene**33.5" Gray-Dun Jennet, 6/23/01, #31076****Merry-Go-Round's Bunnie****Gray-Dun Jennet Foal, 4/16/06, Reg # Pending****Consignor: Merry-Go-Round Mini's**

Soulene is a lovely sweet jennet with a good black pedigree. Her dam Nina II has a stripe with brindling down her back. Soulene's foal, Bunnie, was born on 4/16/06 (sired by Merry-Go-Round's Carbon Black, 32" black by DD Aces High X Merry Go Round's Sootie). She is a super nice gal with a great black pedigree. These gals are a great way to put some black genetics into your herd or get a start on some. Soulene sells open to breed to your jack.

27

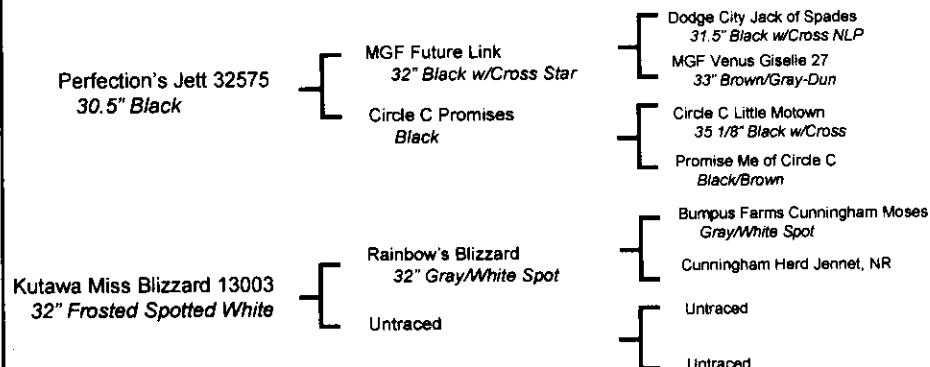
Perfection's Snow Me**Dark Brown & White Spotted Jennet, 11/3/05, Reg. # Pending****Consignor: Perfection Miniature Donkeys, 19" at Birth**

Snow Me, Show Me, What a jenny! A full sister to our white and black spot jennet, "Crystal Clear" who was 3rd in the yearling class at the 2005 NMDA Nationals. Snow Me will be shown at the Calgary 2006 World Champion Miniature Donkey Show. Glistening in the sun with all her spots, there may not be a more beautiful donkey. Snow Me will catch your eye, take your breath away and steal your heart... Beware, love is hard to deny!

28

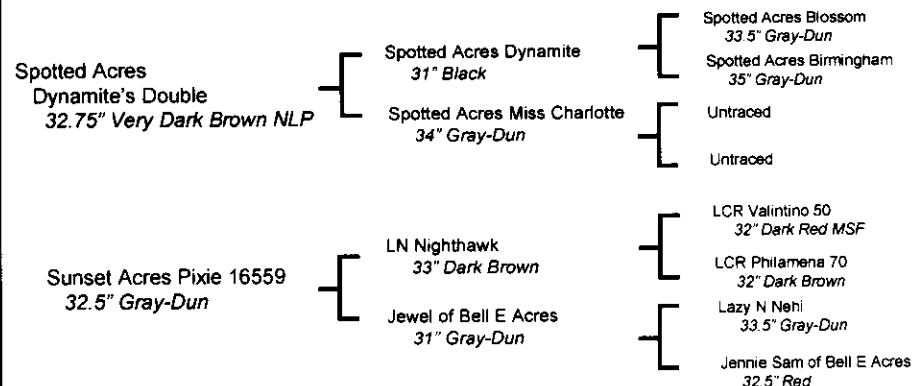
LER Miss Glamor Girl**Dark Brown Jennet, 6/19/05, Reg. #44360****Consignor: Lamb's Exotic Ranch, 19" at Birth**

Miss Glamor Girl has all the characteristics of becoming a model for you. Great body conformation, correct bite, real straight legs, and a wonderful disposition. She measured 19" at birth, going to be small. Sired by a 32.75" black jack, "Dynamite" that has produced several nice foals. Glamor Girl is a full sister to Knite-N-Gail that sold in the 2005 sale for \$5900.

29

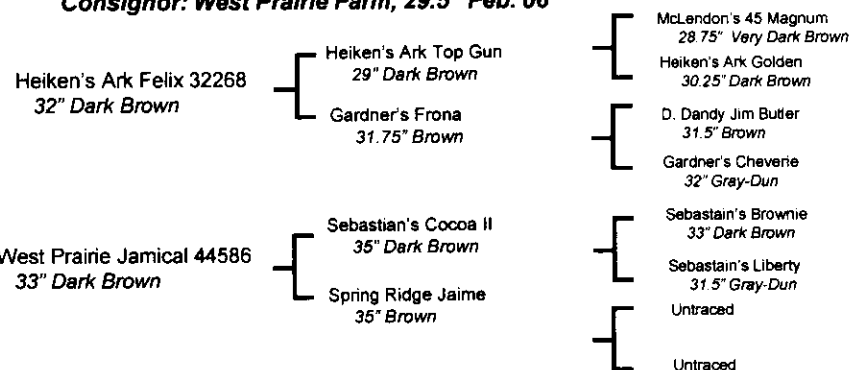
West Prairie Janice**Brown Jennet, 10/2/04, Reg. #45594****Consignor: West Prairie Farm, 29.5" Feb. 06**

We think Janice is a fantastic little jenny with her great conformation, nice head & neck, and gentle disposition. Her desirable pedigree has many with dark genetics, including those of her sire, Heiken's Ark Felix, a 32" dark brown and grand sire, Heikens Ark Top Gun, only 29" tall. We have been breeding donkeys for 15 years, and although our herd is not large, we are proud to offer Janice as representative of the quality we are producing. Janice should make a great addition to most herds.

30

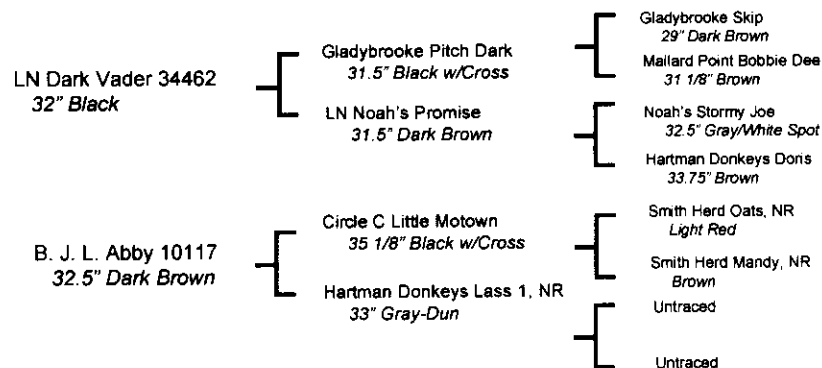
LN Abbavail**Dark Brown Jennet, 7/13/03, Reg. #37920****Consignor: 'Bray'n Pool, 31.25" Mar. 06**

Abbavail is a sweet and correct little jennet. She inherited the great carriage and head from her sire, Dark Vader. Abbavail is carrying lots of black on both sides from LN Dark Vader and GB Pitch Dark on the top side of her pedigree, and Little Motown on the bottom. This girl will be a great addition to any black breeding program, and she will stay small. Lots of eye appeal in this fine boned little girl. She sells open to breed to your jack.

31

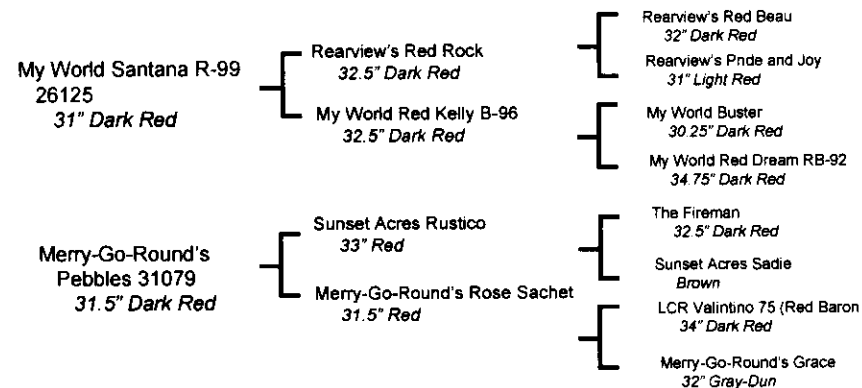
The Elms Tiny Rose**Dark Red Jennet, 5/14/05, Reg. # Pending****Consignor: Elms Farm Miniature Donkeys, 19.25" at Birth**

A very nice jennet in a small package! She is small, and stocky with beautiful, red color. Santana is a spectacular, dark sorrel jack, and so is Pebbles, her mother. Lots of dark sorrel in the pedigree as well. We are impressed with this jennet, and think you will be too. Take a good look at her presence and build.

32

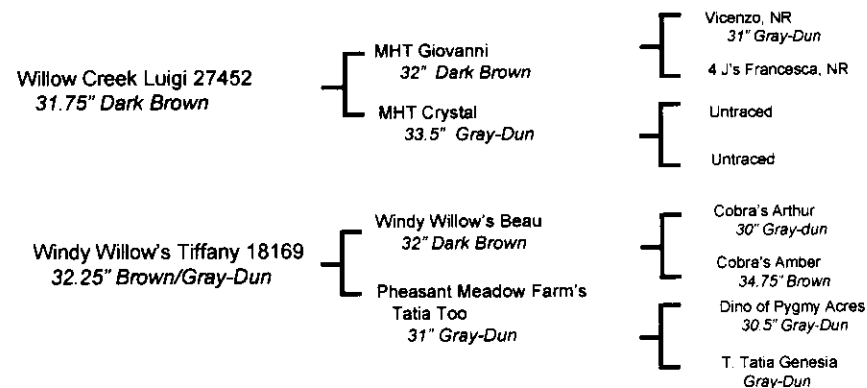
GAF Black Beauty**Very Dark Brown Jennet, 1/12/05 Reg. #42600****Consignor: Great Asspectations Farm, 20" at Birth, 30" Mar. 06**

What a wonderful sweet baby. She has her mom's and dad's excellent conformation. Her sire is the 2004 ADMS National Halter Champion- Luigi. With her conformation, color and bloodlines, she will do well in the show ring and/or fit well into any breeding program when she matures. She has a very willing eager to please attitude.

33

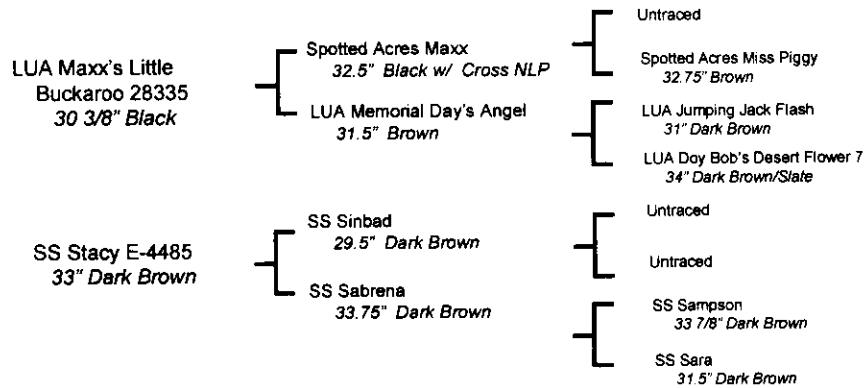
Heiken's Ark Suzi LB**Black Jennet, 9/8/05, Reg. # Pending****Consignor: Heiken's Ark**

Suzi LB is a little jennet whose foal coat is black. Her pedigree contains nothing but dark brown or black, until you get to the 5th generation where there is a 31" gray. Her parents are stocky and well built. She captures your heart with her looks and personality.

34

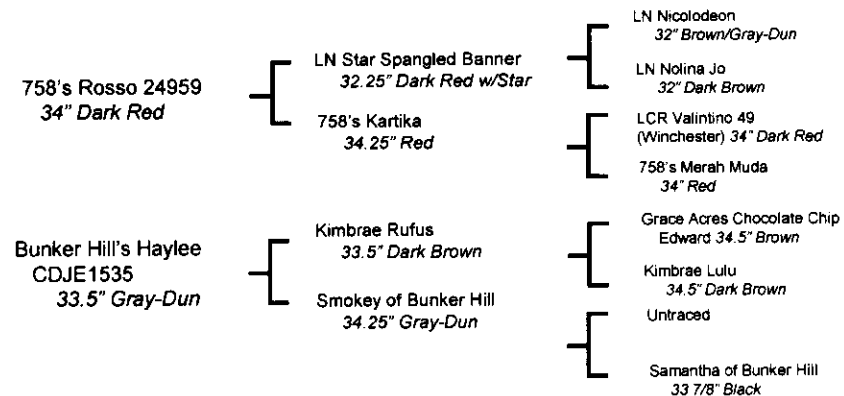
McHugh's Dark Obsession**Dark Brown Jennet, 7/29/04, Reg. #CDJE-4189****Consignor: Linda McHugh, 22" at Birth, 31" Mar. 06**

Dark Obsession is her registered name but her call name is Jasmine. She will be two years old on the day of the sale. Jasmine is very friendly and just loves people. She will make a great addition to anyone's herd and breeding program.

35

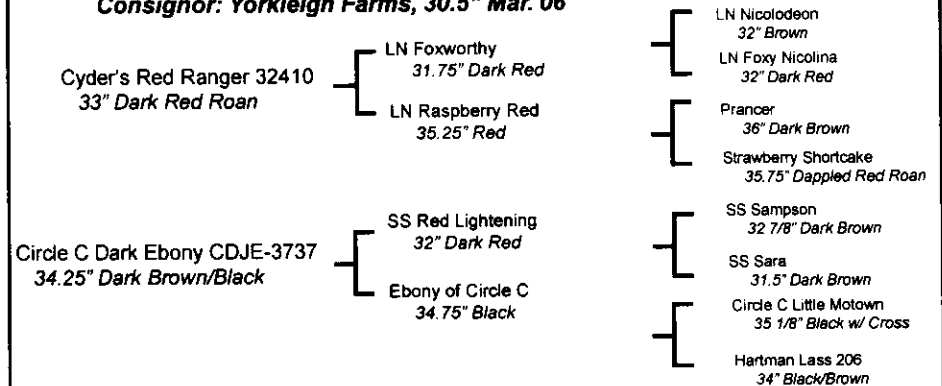
Yorkleigh Farms Dark Essence**Black w/Cross NLP Jennet, 7/26/05, Reg. # Pending****Consignor: Yorkleigh Farms, 30.5" Mar. 06**

Dark Essence is black and stylish, and oh what a pedigree! You have Foxworthy on the sire's side and Red Lightening on the dam's, so how can you go wrong? Her dam, Circle C Dark Ebony, was Reserve Grand Champion as a 2 year old at Millarville, Alberta. Her sire, Cyder's Red Ranger has it all; pedigree, color, & conformation. Essence possesses the same elegance as her half sister, Dark Dubonet, sold at auction last year. If you want excellent genetics combined with show ring looks, this is your girl.

36

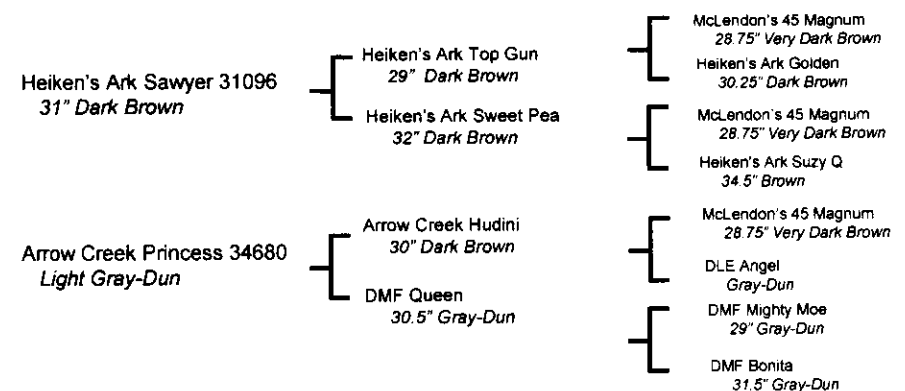
Gardner's Petawa**Dark Brown Jennet, 6/10/04, Reg. #44802****Consignor: Hill's Haven, 29.75" Mar. 06**

Petawa was only 21" at birth. She's staying small, but very stocky, in butt and chest, like her sire Heiken's Ark Sawyer, and grandsire, Heiken's Ark Top Gun. Going on back to the great 45 Magnum at 28.75".

37

MGF Bright Passion Flower 437

Frosted Spotted White/Light Red Jennet, 7/4/04, Reg. #45742

Consignor: McRoberts Game Ranch

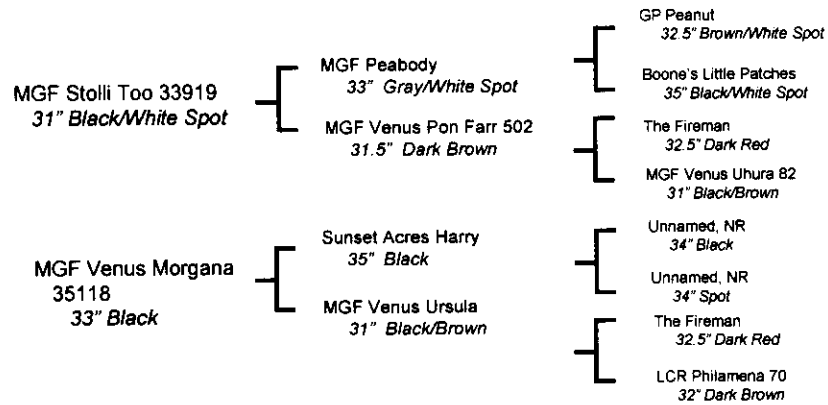

This unique sorrel spot is stocky with plenty of hair in her background from her father, MGF Stollie, Too, and her mother MGF Morgana - a black Harry daughter. Top that off with good bone, and her alert expression, and the fact that she carries herself with style, and you have one dynamite package in Bright Passion Flower.

38

Lil' Half Pints Lil' Tootsie Roll

Dark Brown/Black Jennet, 6/1/05, Reg.# Pending

Consignor: Lil' Half Pints, 15.25" at Birth, 25" at 10 mos

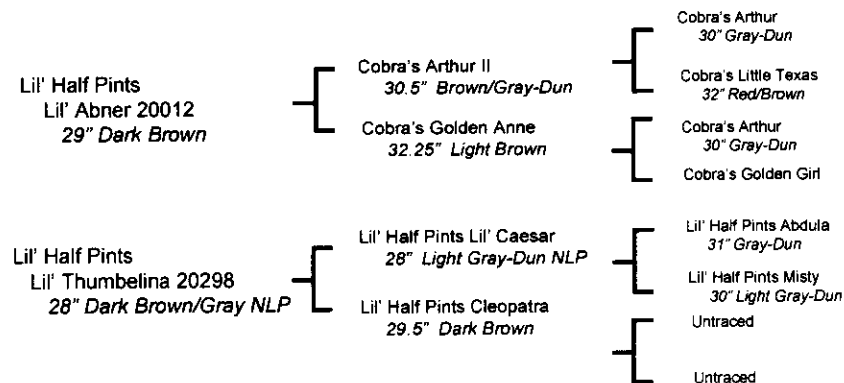

This tiny dark jennet is a sweetheart and just too cute! She has real eye appeal and a gorgeous petite head. You couldn't ask for a prettier head. Lady Fisher of England purchased her full brother at the age of one month. Her 28" brother is in our herd and has sired black and sorrel foals, bred to gray jennets. We also have her full sister who is a true black and shines like black patent. If you are looking for tiny size & colored genetics, you should consider Lil' Tootsie Roll.

39

GP Pepsi

Gray-Dun Jennet, 2/28/05 Reg. #43928

Consignor: Golden's Point, 17" at Birth

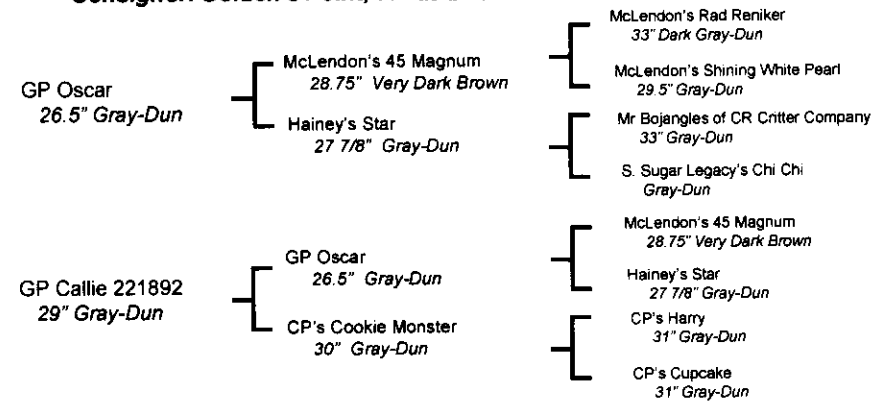

Little Pepsi is a full sister to Kool Aid, Sprite, and Gator Aid, past super stars at the NASS, and some of the smallest donkeys to ever sell at public auction. The line breeding of "Oscar" has resulted in another tiny, toy (to die for) jennet. You will never find any smaller genetics and sweeter personality!

40

HHAA Hula Hoop

Black Jennet, 5/3/05, Reg. #43203

Consignor: Half Ass Acres, 22.5" at Birth

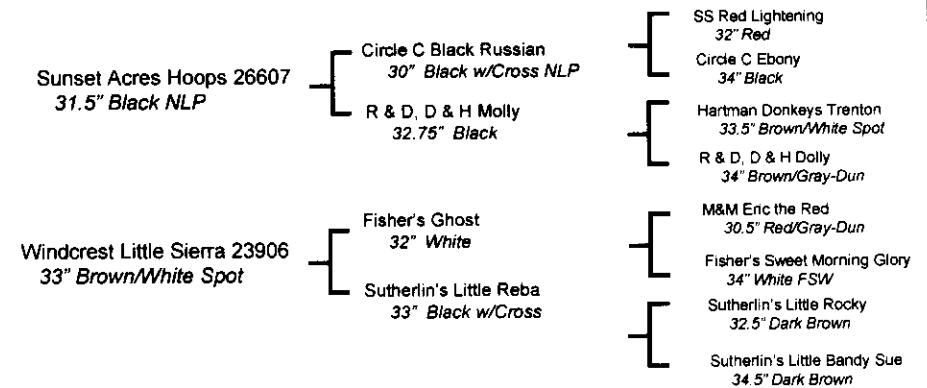

This is a very special girl for more reasons than one. Hula tried so hard to be a no light points jennet and she almost made it except for one tiny smudge on the bridge of her nose. Everything else is totally black.... The inside of her ears, her eye rings and her belly. We won't know for sure until she is body clipped, but so far there is not one hint of a cross. Her sire is a true black with no light points.

41

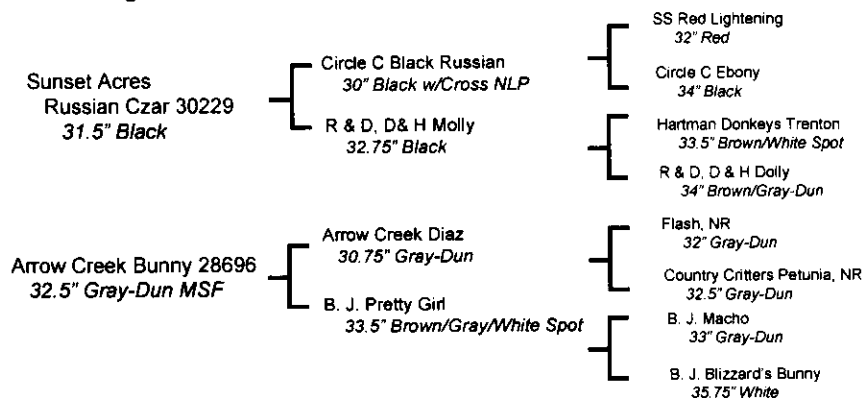
Short & Sweet Casablanca**Gray & White Spotted Jennet, 3/19/04, Reg. #41644****Consignor: Short & Sweet Donkey Ranch, 30.75" May**

Cassie will be an asset to anyone's breeding program, but especially if you are breeding for blacks or dark spots. Her full brother is black with no stripe. Even before she reached her second birthday she had already filled out, and she's staying small, hard to find in a spot. Cassie has that 50-50 color pattern that the judges look for in ACOSA classes. The judges placed her 3rd and 4th in the spotted class at the Lone Star State of Stars show in Conroe, TX last summer.

42

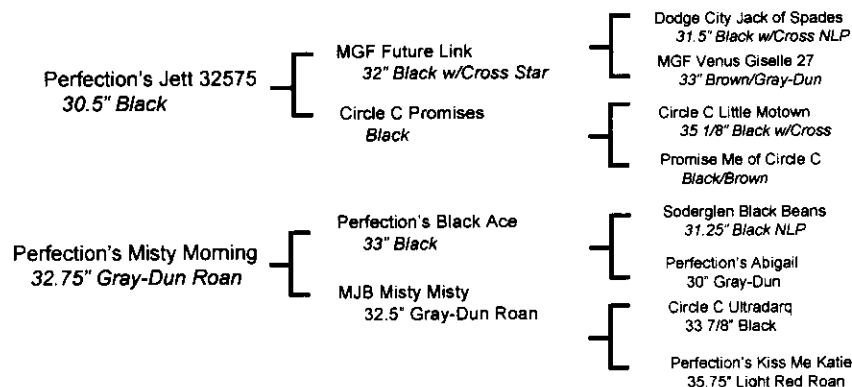
Perfection's Good Morning**Gray-Dun Roan Jennet, 7/27/05, Reg. # Pending****Consignor: Perfection Miniature Donkeys, 20" at Birth**

4 GENERATIONS of Perfection Breeding!! Good Morning is very stocky with a beautiful roan color. The Misty line consistently throws beautiful foals that glisten like sugar coated grapes (roan). Good Morning will be shown at the 2006 World Champion Miniature Donkey Show in Calgary. Cuter than Cute, you will want to wake up every morning to GOOD MORNING!

43

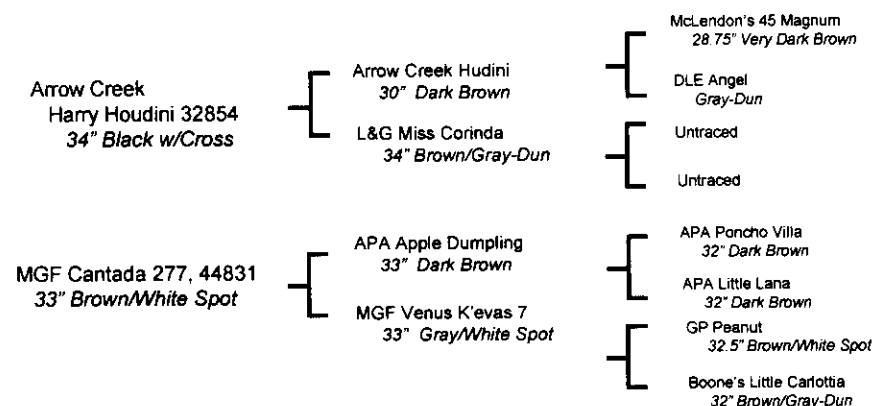
MGF Warm Fuzzy 533**Black Woolly Jennet, 4/25/05, Reg. #45745****Consignor: McRoberts Game Ranch**

This super woolly young jennet is the nicest hairy black jennet we've raised. Sired by the same jet black jack as last year's Ebony and Ivory. For 15 years we have been selecting miniature donkeys for a super long hair look. Warm Fuzzy has the longest hair yet to come out of our breeding program.

44

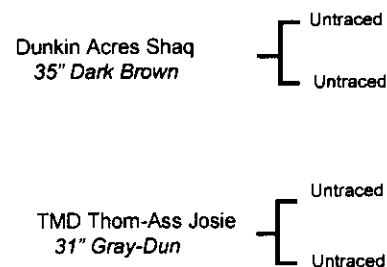
TMD Thom-Ass Rowdy**Harness Trained 34.5" Gray-Dun Gelding with Cart and Harness****Consignor: Little Bit of Heaven, 2/26/02, Reg #33829**

Rowdy is a nice gelding that has been shown and has done very well in Halter Classes. He also coon jumps. He is being sold with a new cart and quality harness. He's ready for someone to take home and enjoy.

45

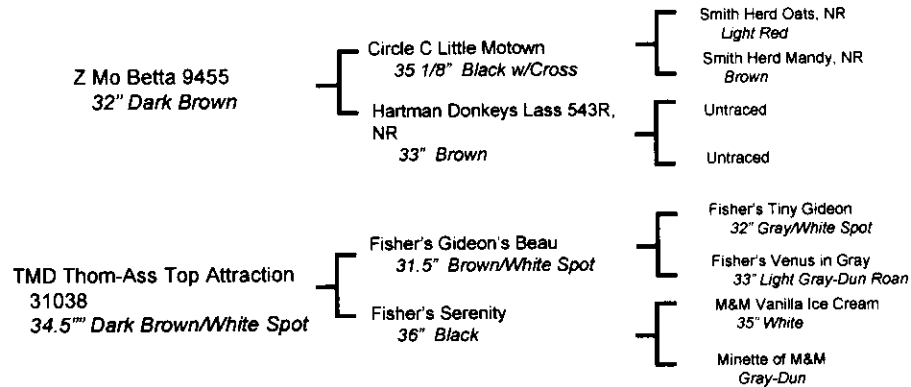
Long Run City of Angels**Very Dark Brown Jennet****Consignor: Long Run Farm, 6/6/04, Reg #43858**

Long Run City of Angels is a rich dark brown that looks black. She has a people loving disposition that has made her a farm favorite since birth. She is bred to perform as the daughter of Z Mo Betta (Thom-Ass Acres winning show jack) and granddaughter of the great Circle C Motown. She is balanced with a long graceful neck that will make that perfect picture in harness. Spots in her background make her an excellent prospect to produce color.

46

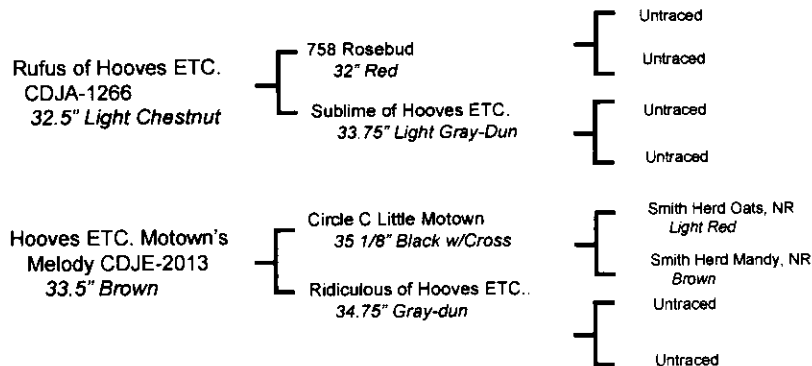
Hooves Etc. Roxanne**34.75" Pale Gray-Dun/Light Red Jennet, Bred for 2007****Consignor: Yorkleigh Farms, 6/6/99, Reg #CDJE-3605**

The decision to part with Roxanne was a very difficult one. She's a sweet donkey with a loving personality. We decided to breed her to our herd sire, Cyder's Red Ranger, for a spring 2007 foal since she produced a very nice jack foal in 2005. Roxanne's grand dam produced two Calgary Stampede Champions and Roxanne captured a Grand Championship at Millarville, Alberta. She should produce sorrel with the right breeding. Roxanne is a donkey you will fall in love with and will be a great asset to your breeding program

47

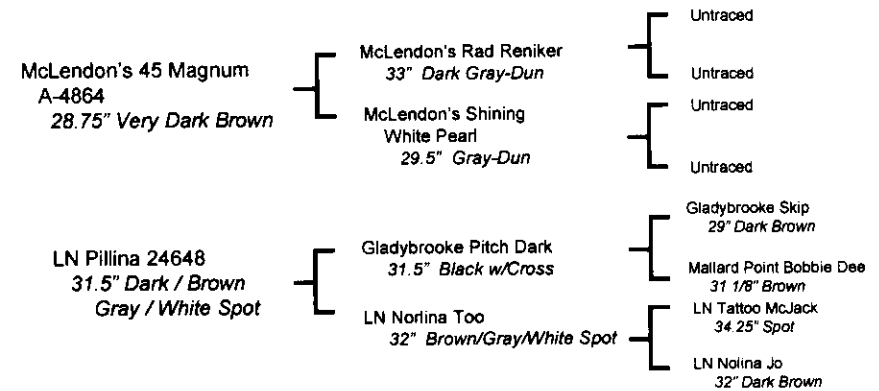
Heiken's Ark Pippi M**Black/Brown & White Spotted Jennet, 7/24/05, Reg. # Pending****Consignor: Heiken's Ark**

Pippi M is a young jennet who speaks for herself. She is a flashy spotted daughter of Magnum. Her dam is LN Pillina who is a 31.5" dark brown/gray and white spotted jennet with a full pedigree. Pippi M is certainly that beautiful spotted jennet who carries herself with style and would make you as proud to own her as we are.

48

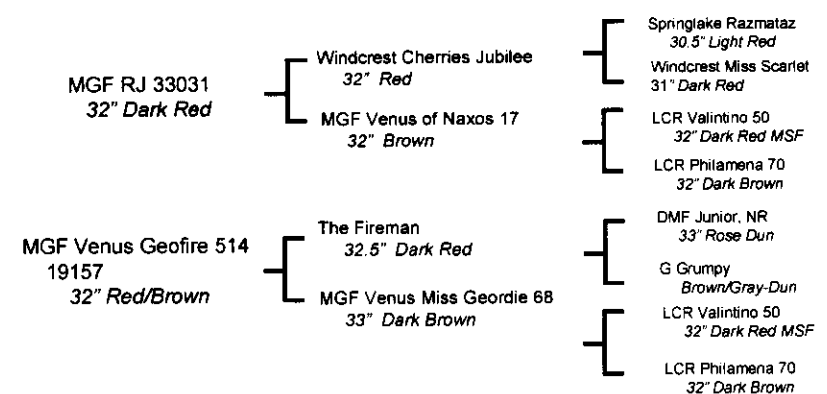
MGF Light My Fire 487**Red Jennet, 9/6/04, Reg. #45744****Consignor: McRoberts Game Ranch**

Light My Fire is an exceptionally small dark bright sorrel from our best sorrel cross —MGF RJ and a Fireman daughter —MGF Geofire. She should mature at 32" or less. Light My Fire sells with a breeding to MGF Husker Pride, a beautiful red, black and white spot jack.

49

Frontier Legends *Shawnee*

Dark Red/Brown Jennet, 11/12/05, Reg. #45589

Consignor: Frontier Legends Miniature Donkeys

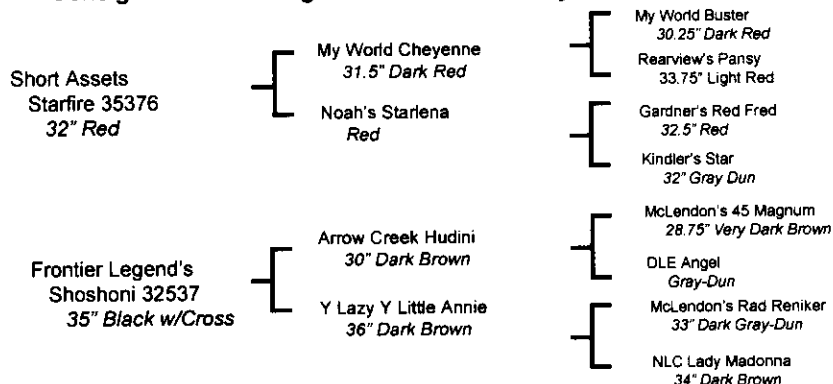

Shawnee is a beautiful russet colored jennet with black legs (bay). Her sire is Frontier Legend's young champion winning sorrel jack, Short Assets Starfire. Starfire has 5 Champion, 2 Grand, & 3 Reserve titles; very impressive for a sorrel. Her dam, a black jennet, has a show record, including a Reserve Champion, 1-1st, a 4th and a 5th. She has a very nice pedigree including My World, Rearview's, and McLendon's. Here is a fine little jennet with lots of positives.

50

MGF *Venus Mink*

Dark Brown NLP 32" Jennet, 8/14/95, Bred for 2007

Consignor: Half Ass Acres, Reg. #19432

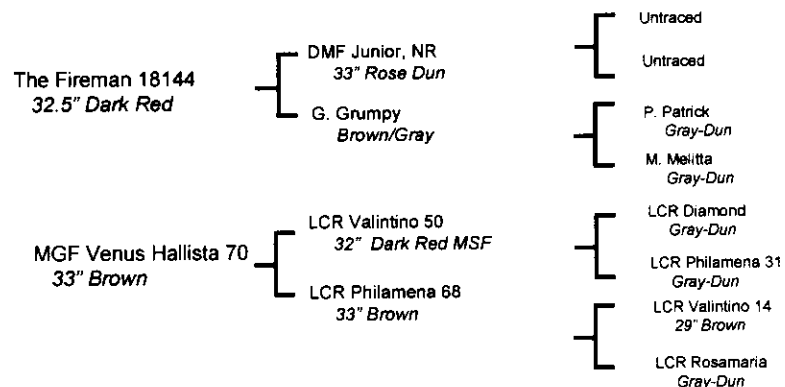

Here is your chance to own a NLP dark daughter of the legendary Fireman! Mink is a very beautiful jennet with a perfect bite and a nice round rump. She has had several foals with no problems. She has been bred to our stocky 32.25" few spot white jack, Ass-Pirin Acres Spectacular, for a 2007 foal. When clipped she is drop dead gorgeous!

51

West Prairie *Fancy*

Brown Jennet, 8/26/04, Reg. #45595

Consignor: West Prairie Farm, 29" Feb. 06

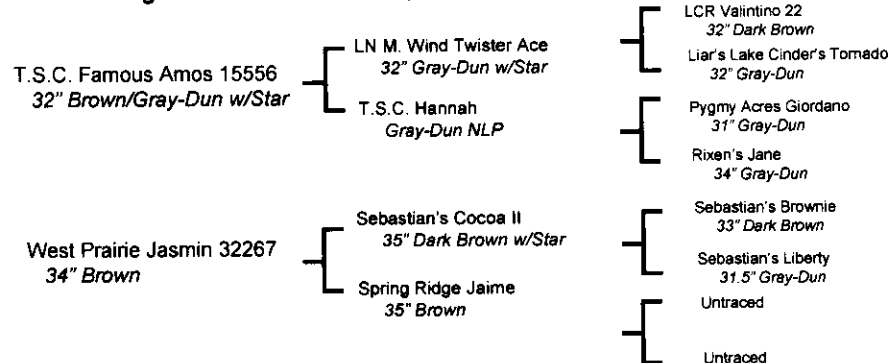

Fancy is her name and she is Fancy. Her sire is T.S.C. Famous Amos, height 32" brown. Her dam is West Prairie Jasmin brown height 34". Fancy is 29" tall at 18 months. She has a black stripe and a few white hairs on her forehead. Great lines, great feet and legs, great body, and fantastic head. Jennys run in her dams side. She has dark genes in her blood line. Take a good look at this jenny.

52

Feather Ridge's *Molly*

Dark Gray-Dun NLP Jennet, 7/21/05, Reg. # Pending

Consignor: Feather Ridge Farm, 30.25" Feb.

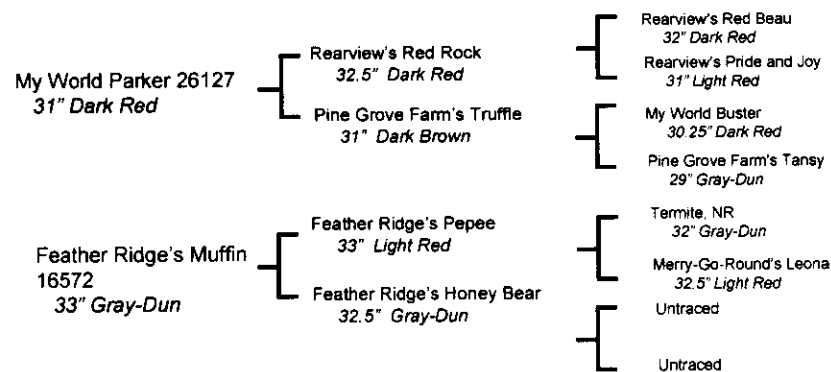

Molly is a stocky, well built little jennet. She gets her good bone from her dad, My World Parker. Her mother consistently gives me wonderful quality babies. She is out of a very old line of donkeys and has a lot of color in her pedigree. Molly's mother, Muffin, has a very sweet loving nature, which has already rubbed off on her.

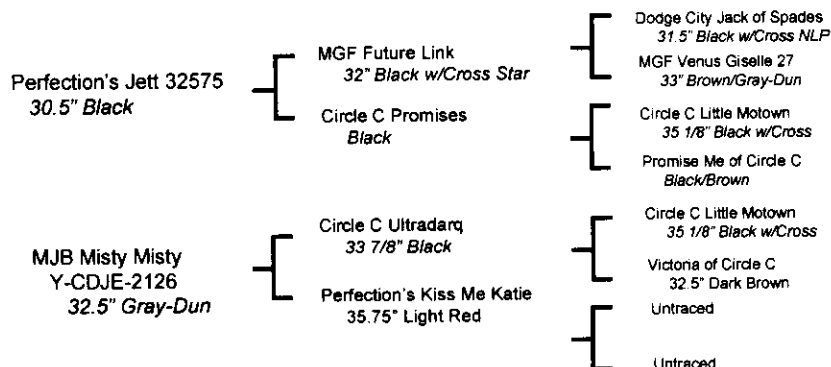
53**Perfection's *Misty Maid*****Dark Brown Roan Jennet, Sept. 1, 2005, Reg. # Pending****Consignor: Perfection Miniature Donkeys, 19.5" at Birth**

If color, genetics, conformation & disposition wrapped up in one sweet package is what you crave, look no farther than MISTY MAID. Her color is like divine chocolate iced with the fine sugar. You won't find a more exotic color pedigree, than this 3rd generation roan, with her strong black heritage. Misty Maid will be shown at the Calgary 2006 World Champion Miniature Donkey Show. Like a sweet chocolate, Misty Maid will be desired by all, but only one can have her....

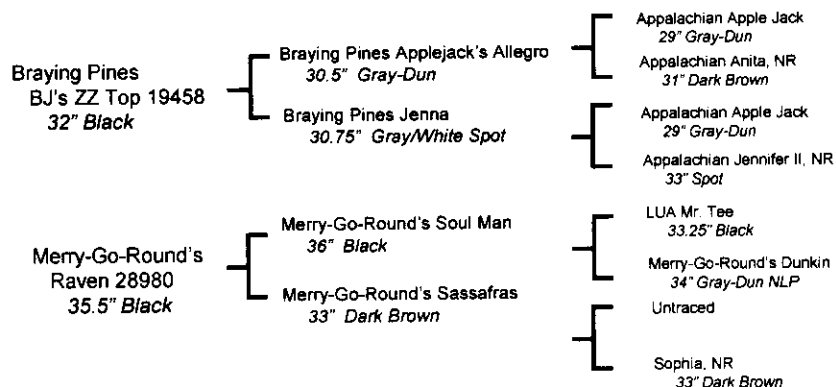
54**Merry-Go-Round's *Black Olive*****Black Jennet. 5/2/05, Reg. # Pending****Consignor: Merry-Go-Round Minis, 31.5" Mar. 06**

Here is a real sweet, nice black jennet. She has good bone and conformation and great genetics. Both parents are black - she and Girlfriend have the same sire, ZZ Top.

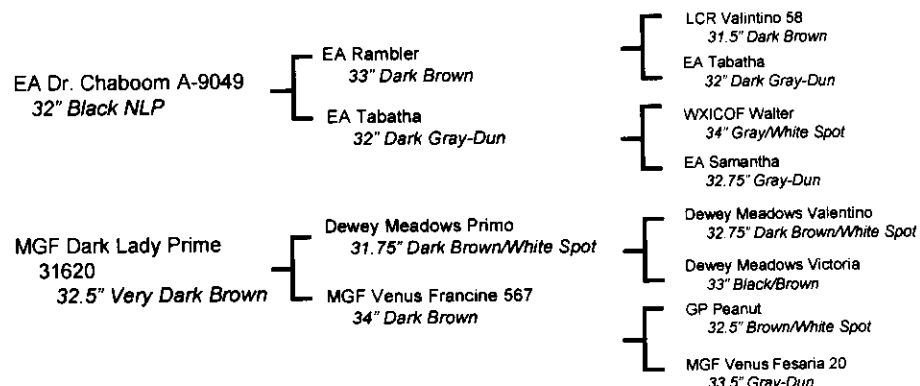
55**The Elms *Moon Shadow*****Dark Brown Jennet, 5/25/05, Reg. #Pending****Consignor: Elms Farm Miniature Donkeys, 22" at Birth**

Shadow is a beautiful jennet, almost black when she was born. She has a lot of style. Her dam is half sister to our jack, Black Knight, and we can see the family connection with her alert, expressive head. Chaboom brings a different black bloodline to the mix. A lovely jennet that would complement anyone's color breeding program for solids or spots.

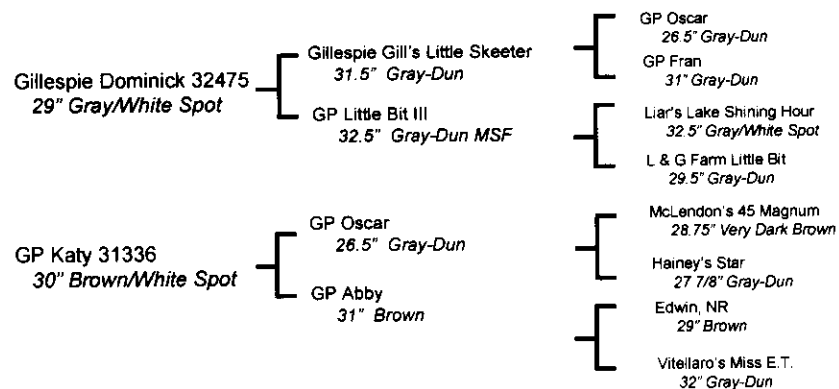
56**GP *Sage*****Brown & White Spotted Jennet, 1/15/05, Reg. #43931****Consignor: Golden's Point, 19" at Birth**

Sage is a flashy, loud colored, brown and white spotted yearling that will be an eye catcher in anyone's pasture. She is a drafty, cobby, and affectionate girl that traces back to "Oscar" on both sides of her pedigree with lots of additional brown and black genes.

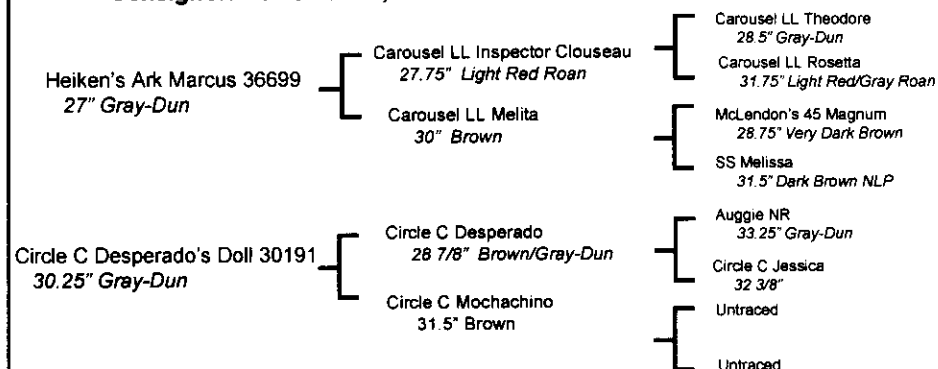
57**Heiken's Ark Dottie MR****Red Jennet, 7/6/05, Reg. #43854****Consignor: Heiken's Ark, 20" at Birth**

Dottie MR is a very cute, classy, little jennet. She comes from LITTLE stock. Her sire is 27" and her dam is 30.25" and they also come from little stock. Her bloodline contains McLendon's 45 Magnum at 28.75", Circle C Desperado at 28 7/8", and Carousel LL Inspector Clouseau at 27.75". Her birth height was 20" so she should mature at 30 to 31". She has color, small size, and great conformation. She should fit in with most everyone's breeding program.

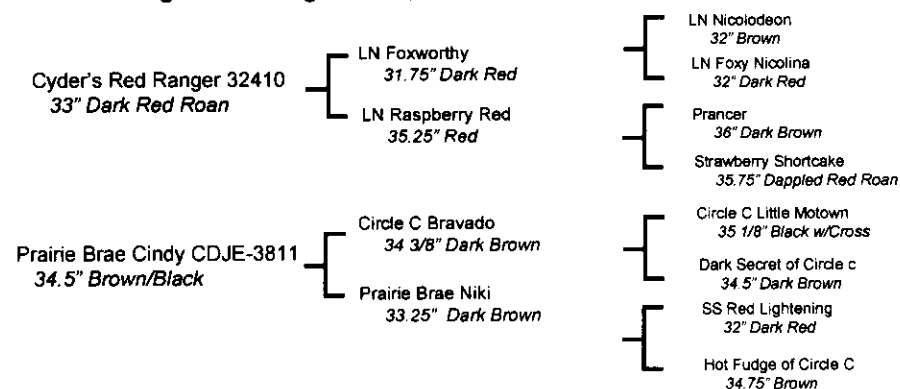
58**Yorkleigh Farms Chiquita****Dark Brown Jennet, 7/4/05, Reg. # Pending****Consignor: Yorkleigh Farms, 30.5" Mar. 06**

We are very pleased to present this Foxworthy granddaughter. Chiquita is very compact and has great conformation. Her dam, Prairie Brae Cindy, placed 2nd in the 2 year old jennet class at the Calgary Stampede in 2003. Her sire, Cyder's Red Ranger has proven genetics and consistently passes on his correct conformation and style to his foals. Chiquita is an excellent example of what our breeding program is about. Please give her careful consideration.

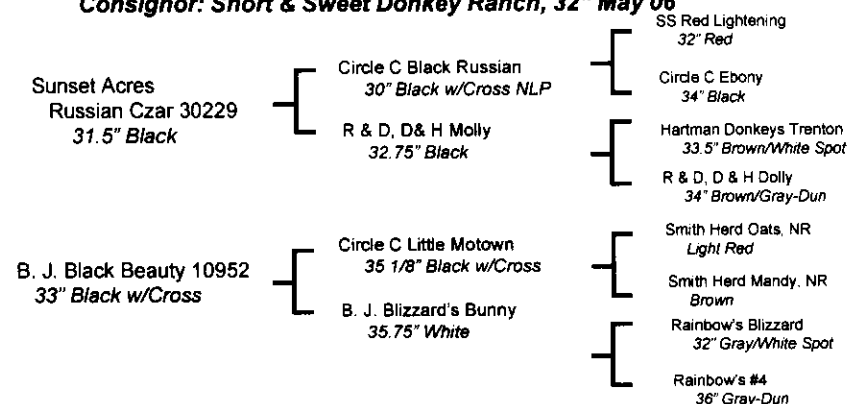
59**Short & Sweet Raven's Fire****Black Jennet, 4/21/04, Reg. #41643****Consignor: Short & Sweet Donkey Ranch, 32" May 06**

Raven is a very striking jennet with her black color and her contrasting light points. As a two year old she has already started filling out nicely. She has excellent bloodlines. Raven placed 3rd at the 2004 SDMS September show in the foal class... her very first show. She also placed 4th in the 0 to 1 year old halter class at the 2004 Dallas State Fair. She is going to be a small, solid jennet that anyone would be happy to have in their herd.

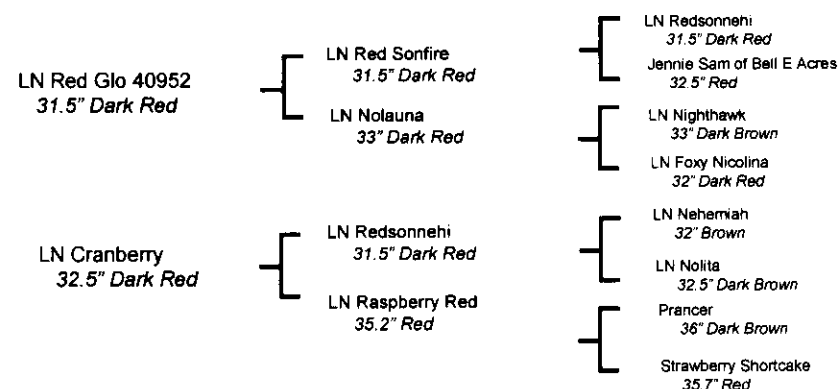
60**LN Berry Red****Dark Red Jennet, 9/12/05, Reg. # Pending****Consignor: Lazy N Ranch, 23.5" at Birth**

Berry Red, by our chestnut herd sire, Red Glo, is that rich red color in appearance as well as genetically. Both sides of her family lineage trace back to the old import donkeys & with many Halter Champions and Champion producers clear back thru the great grandparents. Combining all that, along with a very stylish and appealing look, Berry Red is an exceptionally special jennet in all aspects.

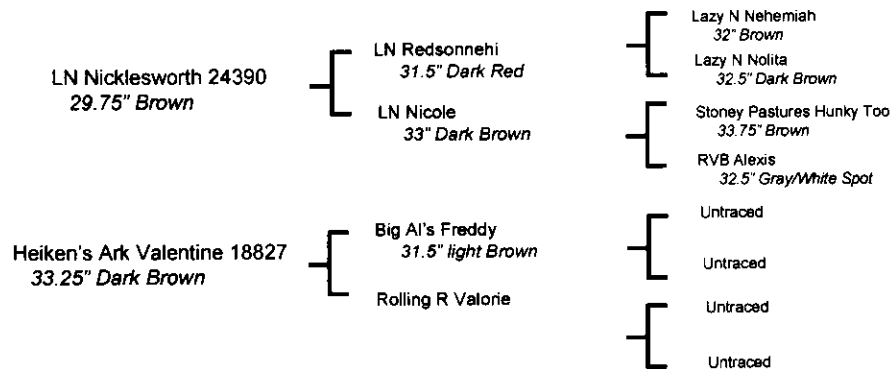
61**Heiken's Ark Vicki****31.75" Dark Brown Jennet, Bred for Fall 2006****Consignor: Gusty J Ranch, 7/13/02, Reg #35891**

Vicki is a nice straight little donkey, 31.75" and her first foal is staying nice and small, and was 19" at birth. We are selling her because we want to have our herd 30" or smaller. She is bred to our 29" Wyoming State Champion Jack, Heiken's Ark Sterling for Fall 2006

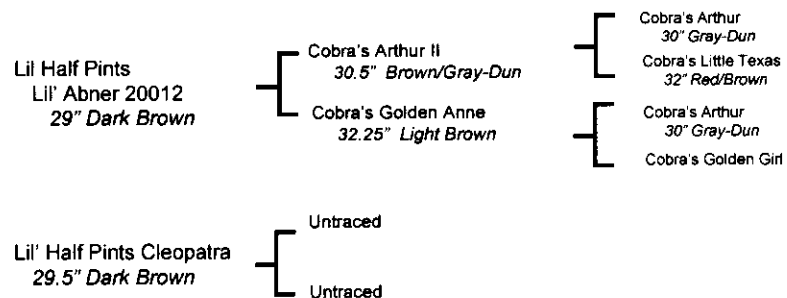
62**Lil' Half Pints Lil' Mary Jane****29.75" Light Black w/Cross NLP Bred for 2007****Consignor: Lil' Half Pints, 3/11/03, Reg #Pending**

We have been breeding miniature donkeys for over 40 years and it is difficult to find a jennet of this size and quality. She is due to foal in April 2007 by our silver 25" Lil' Romeo. His brother had a successful show career in New Zealand. Her sister had a true black jennet sired by Romeo, and I will show her. "MJ" is the only Cleopatra daughter that we have offered for sale. Like her mother, father, sisters, and brother, "MJ" and her foal have the genetics to put color, tiny size and show quality into your breeding program.

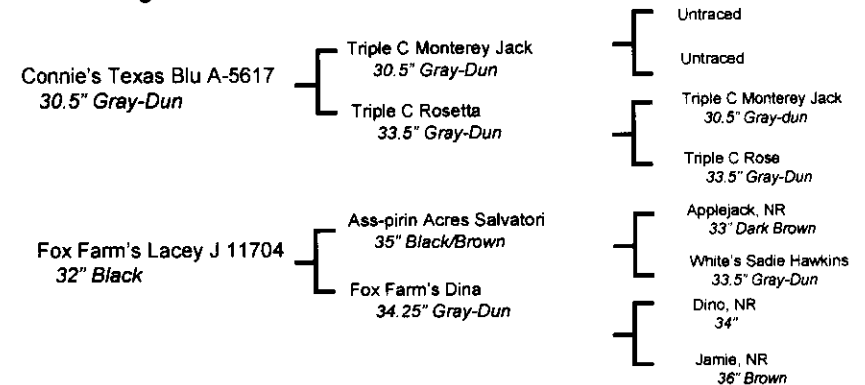
63**Heavenly Nina****32.25" Gray-Dun Jennet, 7/28/00, Reg. #31732, Bred for 2007****Heavenly June Bug,****22" Light Red w/Blaze Jennet Foal, 6/2/06, Reg. # Pending****Consignor: Little Bit of Heaven**

Nina - She is a lovely gray, nice brood jennet and has June Bug, a light sorrel jennet foal, with a blaze face, by her side. June Bug is sired by LN Dark Jo, a nice square 32" black/brown jack. Nina is bred back to Dark Jo for a 2007 foal.

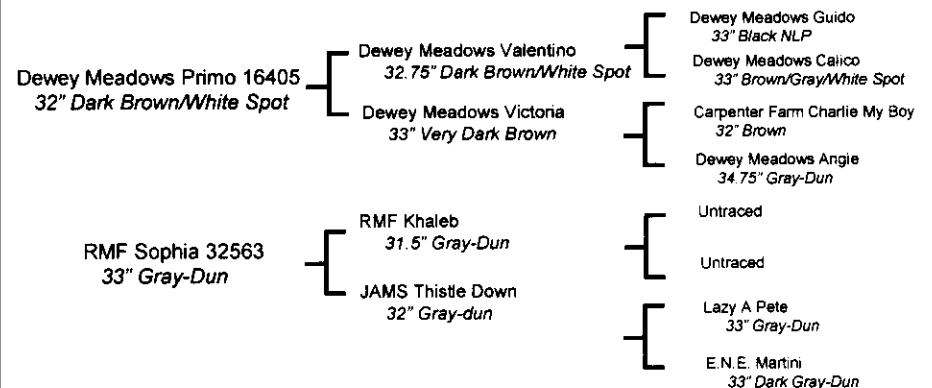
64**KZ Taramasue****Dark Brown Jennet, 6/9/05, Reg. #44195****Consignor: KZ's Ass-Piration Acres, 20.5" at Birth**

Taramasue is a petite, dark brown, well put together yearling. If she matures out at 31" I would be surprised. With her sire being one of America's well known small dark spotted jacks, she would be an asset to anyone's breeding program. If you are looking for a jennet who will be small, dark, and would produce dark spots, look no further. Taramasue is for you!

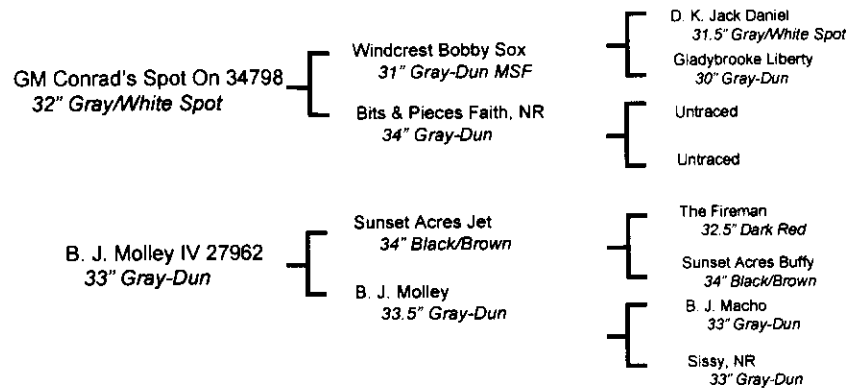
65**B. J. Daisy Spot****Black & White Spotted Jennet, 5/4/05, Reg. # Pending****Consignor: Gold Mine Farm, 22.5" at Birth**

Looking for spots? Daisy certainly stands out in every crowd. She is a friendly little jennet with a good pedigree. Look closely at this classy little gal, buy her, then take her home and enjoy spots in your own pasture.

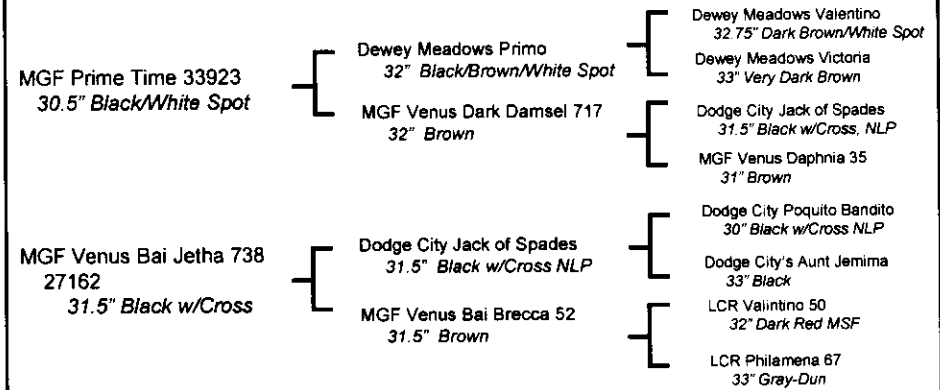
67**MGF Just a Prima Donna 490****Black w/Cross Jennet, 11/15/04, Reg. #45743****Consignor: McRoberts Game Ranch**

This super stocky black jennet is by our super 30" black and white spotted jack, out of a great Jethro (Jack of Spades) daughter. Friendly personality, first to the gate, just tops off the package!

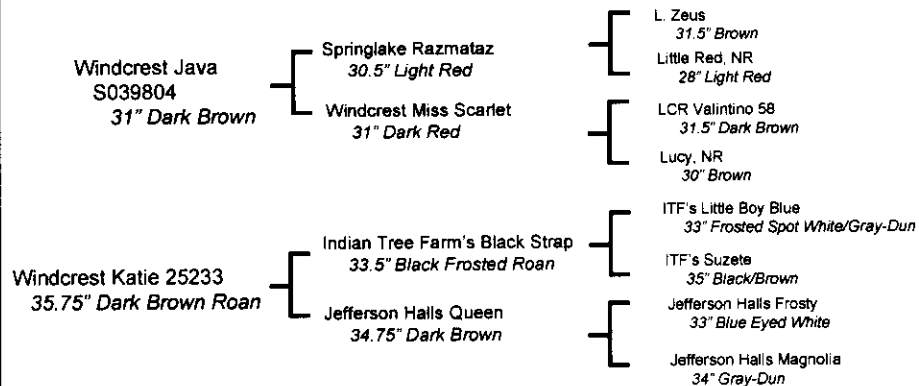
66**Long Run Millie****35.25" Black w/ Cross Jennet, Bred for 2006, Harness Trained****Consignor: Long Run Farm, 4/6/00, Reg #26788**

Millie is a beautiful dark jennet with a super disposition that produces correct stocky foals. Her foal is by Cash Box, a son of National Champion Cash Dividend, and she will sell bred back to a son of National Champion George Jones. Millie's Sire is Windcrest Java, giving the buyer a 3 in 1 package that combines 3 of the top bloodlines in the nation.

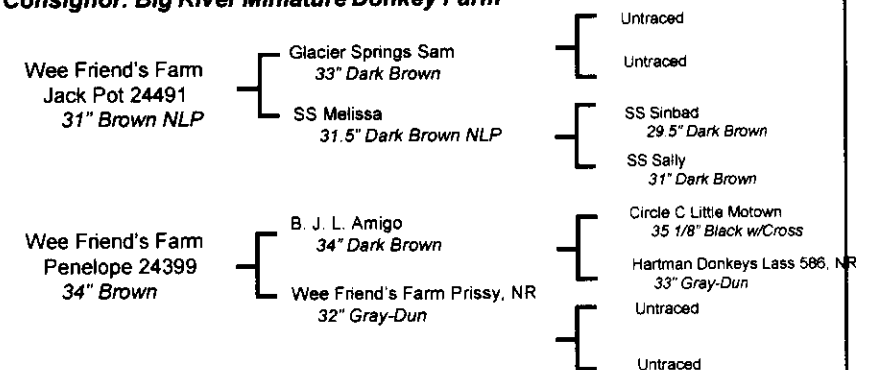
68**Wee Friend's Farm Skippy****34" Brown Jennet, 7/24/97, Reg. #29750, Bred for 2007****Big River Black Lightning****Black Jennet Foal, 5/14/06, 22" at Birth, Reg. Pending****Consignor: Big River Miniature Donkey Farm**

3 in 1 Family! Skippy is a drafty, well boned donkey with a loving disposition. Skippy carries the Little Motown in her pedigree. Skippy has a black jennet foal at her side, with white points, sired by Happy Jack Acres Lights Out, a 32 3/8" true black jack (MGF Future Link X Hiwest Diamond Rose). She will be exposed back to Lights Out for a 2007 foal.

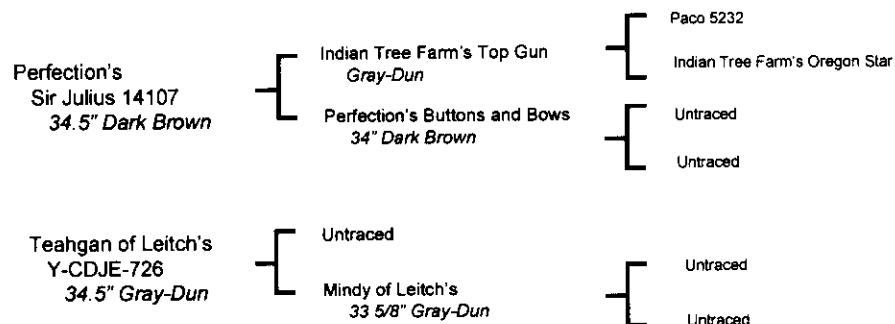
69**Perfection's *Little Critters Julie*****32" Gray-Dun Jennet, Bred for 2006****Consignor: Perfection Miniature Donkeys, 4/20/97, Reg #Y-CDJE-1957**

1, 2, 3; or A, B, C; Julie is a text book jenny. She has very nice foals, is a fabulous mother and then gets pregnant again! What more can you ask for? Julie will have a 2006 foal at side, sired by Perfection's Jett (30.5" Black) and will be bred back by sale time. Don't miss this great 3 in 1 package

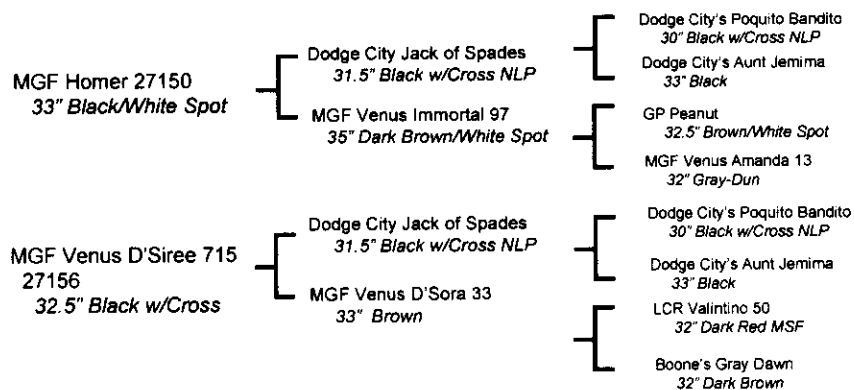
70**Sunset Acres *Kiki*****Dark Brown Jennet, Bred for 2007****Consignor: Elms Farm Miniature Donkeys, 7/12/03, Reg #35864**

Kiki is a lovely, friendly, bred jennet with a ruddy brown color, much darker in her summer coat. Some very nice donkeys from this Jack of Spades line. We have paired her with our new herd sire, The Elms Rembrandt, a flashy, black/brown, wide and straight son of Black Knight. This is your chance to get one of Rembrandt's first foals!

2006 Sale Donkey List

<i>Lot # Miniature Donkey</i>	<i>Lot # Miniature Donkey</i>
1 MGF Apple Blossom	36 Gardner's Petawa
2 Perfection's Gretchen	37 MGF Bright Passion Flower
3 The Elms Rose Chiffon	38 Lil Half Pints Lil Tootsie Roll
4 Short and Sweet InkaDinkaDoo	39 GP Pepsi
5 HHAA Fat Bottom Girl	40 HHAA Hula Hoop
6 GP Nutmeg	41 Short and Sweet Casablanca
7 Lil Half Pints Lil Star	42 Perfection's Good Morning
8 Lil Jackson Ranch Angel	43 MGF Warm Fuzzy
9 Feather Ridge Golden Biscuit	44 Driving Gelding, Harness, Cart
10 Merry Go Round Girlfriend	45 Long Run City of Angels (SUB)
11 MGF Tequila Sunrise	46 Hooves ETC. Roxanne
12 Hill's Haven Josie & Foal	47 Heiken's Ark Pippi
13 LN Little Foxy Vu	48 MGF Light My Fire
14 Long Run Tuscan Sun	49 Frontier Legends Shawnee
15 Heiken's Ark Rosalie	50 MGF Venus Mink
16 Hill's Haven Koko	51 West Prairie Fancy
17 Heavenly Poppy	52 Feather Ridge Molly
18 Yorkleigh Orchid	53 Perfection's Misty Maid
19 Frontier Legends Bandit Queen	54 Merry Go Round's Black Olive
20 KZ's Mena Mime	55 The Elms Moon Shadow
21 AssPirin Acres Callula	56 GP Sage
22 The Elms Jaunty Splash	57 Heiken's Ark Dottie
23 Feather Ridge Olga	58 Yorkleigh Chiquita
24 BJ White Princess	59 Short and Sweet Raven's Fire
25 GJR Lil Glory	60 LN Berry Red
26 Merry Go Round Soulene & Foal	61 Heiken's Ark Vicky
27 Perfection's Snow Me	62 Lil Half Pints Lil Mary Jane
28 LER Miss Glamor Girl	63 Heavenly Nina
29 West Prairie Janice	64 KZ Tamasue
30 LN Abbavail	65 BJ Daisy Spot
31 The Elms Tiny Rose	66 Long Run Millie
32 GAF Black Beauty	67 MGF Justa Primadonna
33 Heiken's Ark Suzi	68 Wee Friend's Skippy & Foal
34 McHugh's Dark Obsession	69 Perfection's Little Critters Julie
35 Yorkleigh Dark Essence	70 Sunset Acres Kiki

See WWW.DONKEYS.NET for Pictures

2007 Great American Miniature Donkey Sale
Sale Day - July 28, 2007

Now is the time to select those special donkeys you will want to represent your farm breeding program in the 2006 Sale. Sale planning begins in December, deadline in February. Contact us anytime to discuss potential entries and details.

Great American Miniature Donkey Sale Catalog, copyright 2006



Elms Farm Miniature Donkeys

Martha & Dowell Howard

5600 Bethany Road

Mason, OH 45040

513-398-3341

WWW.DONKEYS.NET

donkeys@donkeys.net

FIRST CLASS